



**ALLIED MACHINE  
& ENGINEERING**

**WOHLHAUPTER®**

Holemaking Solutions for Today's Manufacturing



Boring



Reaming



Burnishing



Threading



Specials



**T-A Pro®**

► **DRILLING**

High Penetration Replaceable Insert Drilling System





SECTION

---

# A25

---

T-A Pro® Drilling System

# T-A Pro®

## High Penetration Replaceable Insert Drilling System

► **Diameter Range:** 9.50 mm - 47.80 mm (0.3739" - 1.8820")



### The best just got *better*.

After 35 years of spade drilling success with our iconic T-A® (Throw Away) insert, the best just got better. Our team of engineers developed technology that takes The "go-to" solution for general purpose holemaking to a performance level previously unachievable by a spade insert.

The T-A Pro combines material-specific insert geometries, a redesigned drill body, and a proprietary through coolant system to allow penetration rates, which run at speeds faster than other high performance drills.

Your safety and the safety of others is very important. This catalogue contains important safety messages. Always read and follow all safety precautions.



This triangle is a safety hazard symbol. It alerts you to potential safety hazards that can cause tool failure and serious injury.

When you see this symbol in the catalogue, look for a related safety message that may be near this triangle or referred to in the nearby text.

There are safety signal words also used in the catalogue. Safety messages follow these words.

#### **⚠ WARNING**

**WARNING** (shown above) means that failure to follow the precautions in this message could result in tool failure and serious injury.

**NOTICE** means that failure to follow the precautions in this message could result in damage to the tool or machine but not result in personal injury.

**NOTE** and **IMPORTANT** are also used. These are important that you read and follow but are not safety-related.

Visit [www.alliedmachine.com](http://www.alliedmachine.com) for the most up-to-date information and procedures.

Excellent chip control	Improves hole quality and surface finish	Provides maximum durability and stability
------------------------	--	---

### Applicable Industries



Aerospace



Agriculture



Automotive



Firearms



General Machining



Oil & Gas



Renewable Energy

# T-A Pro® Drilling System Contents

## Reference Icons

The following icons will appear throughout the catalogue to help you navigate between products.

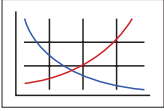

### Recommended Cutting Data

Speed and feed recommendations for optimum and safe drilling

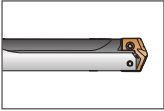

### T-A Pro Holders

Refers to the range of holders that connect with the corresponding inserts



### T-A Pro Carbide Inserts

Refers to ISO-material special coated carbide inserts and HSS inserts that connect with the corresponding holders



### Through Coolant Option

Indicates that the product is through coolant

Series	Diameter Range	
	Metric (mm)	Imperial (inch)
<b>Y</b>	9.50 mm - 11.09 mm	0.3739" - 0.4368"
<b>Z</b>	11.10 mm - 12.69 mm	0.4369" - 0.4998"
<b>0</b>	12.70 mm - 17.64 mm	0.4999" - 0.6946"
<b>1</b>	17.65 mm - 24.37 mm	0.6947" - 0.9596"
<b>2</b>	24.38 mm - 35.04 mm	0.9597" - 1.3797"
<b>3</b>	35.05 mm - 47.80 mm	1.3798" - 1.8820"

## Introduction Information

Competitive Test Results . . . . .	3
Case Studies . . . . .	4 - 5
Insert Comparison and Assembly Information . . . . .	6
T-A Pro Drilling System Information . . . . .	7
Product Nomenclature . . . . .	8 - 9

## Y Series

Inserts . . . . .	10 - 11
Drill Holders . . . . .	12 - 13

## Z Series

Inserts . . . . .	14 - 15
Drill Holders . . . . .	16 - 17

## 0 Series

Inserts . . . . .	18 - 19
Drill Holders . . . . .	20 - 23

## 1 Series

Inserts . . . . .	24 - 27
Drill Holders . . . . .	28 - 31

## 2 Series

Inserts . . . . .	32 - 35
Drill Holders . . . . .	36 - 39

## 3 Series

Inserts . . . . .	40 - 43
Drill Holders . . . . .	44 - 47

## T-A Pro Kits

Drill Holders . . . . .	48
Inserts . . . . .	49

## Recommended Cutting Data

Metric (mm)	[	Carbide . . . . .	50 - 51
		High-Speed Steel . . . . .	52 - 53
Imperial (inch)	[	Carbide . . . . .	54 - 55
		High-Speed Steel . . . . .	56 - 57

## Tap Drill Information and Formulas

Metric (mm) . . . . .	58
Imperial (inch) . . . . .	59

## Deep Hole Drilling Guidelines . . . . . 60

## Troubleshooting Guide . . . . . 61



# T-A Pro®

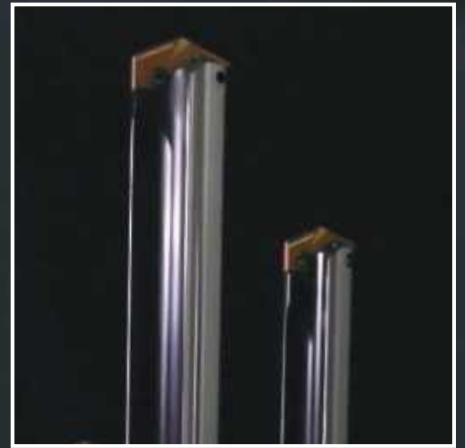

## **NEW** HOLDER DESIGN

Optimised flute design for **increased** chip evacuation



## **NEW** INSERT DESIGN

ISO-specific geometries with a new point design to **simplify** your insert choices



## **NEW** COOLANT DESIGN

Proprietary coolant outlet configuration provides **superior** performance even in low coolant applications 14 BAR (200PSI)

Competitive Test Results

# T-A Pro®

## TEST RESULTS



**Project Profile:** Competitive Testing in 4340 Steel  
**Tooling Solution:** T-A Pro: Steel (P) Geometry with T-A Pro Holder

**The Parameters:**

- Hole Diameter = 14.30 mm ( 0.5625")
- Depth of Cut = 50.80 mm (2")
- Coolant = 20 BAR (300 PSI)
- Speed = 2546 RPM
- Feed = 420 mm/min (16.55 IPR)

**The Results:**

When run at the listed parameters, here is how the three different tooling solutions performed:

**Competitor 1** = 79.95 total linear meters  
**Competitor 2** = 93.67 total linear meters  
**T-A Pro** = **109.62** total linear meters

**Average Tool Life**  
 Test Results Drilling in 4340 Steel

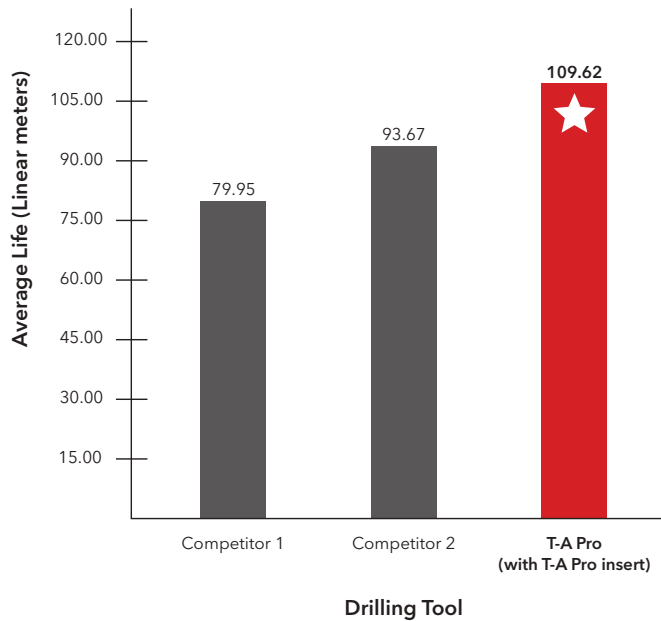

A  
DRILLING

B  
BORING

C  
REAMING

D  
BURNISHING

E  
THREADING

X  
SPECIALS

## Case Study

### The Gift that Keeps Giving.

Not everything in life has to be a give and take. Our customer who machines fluid end frac blocks was previously having to reduce cutting parameters to achieve good chip formation and produce a successful part.

Needing better chip formation with a reduced cycle time, the customer tested Allied's **T-A Pro drill**. Using the "M" ISO-specific stainless steel insert geometry – developed for improved chip formation while minimising exit burr – they were able to increase their speed and feed while maintaining ideal chip formation.

On top of the reduced cycle time, the T-A Pro had an increased tool life, lowering the cost per hole by 58.82%. The success of the T-A Pro in this application is just another example of why it is more than just a good drill.

If you are looking for a solution that just keeps giving, **give us a call and we will help you find the right solution.**



Product:	T-A Pro drill	Measure	Competitor Drill	T-A Pro Drill
Objective:	Reduce cycle time	RPM	480	545
Industry:	Oil & Gas / Petrochemical	Speed Rate	67.06 m/min (220 SFM)	76.20 m/min (250 SFM)
Part:	Fluid end frac block	Feed Rate	0.13 mm/rev (0.005 IPR)	0.20 mm/rev (0.008 IPR)
Material:	15-5 PH stainless steel	Penetration Rate	60.96 mm/min (2.4 IPM)	111.76 mm/min (4.4 IPM)
Hole Ø:	44.45 mm (1.75")	Total Part Cycle Time	500 sec	272 sec
Hole Depth:	508.00 mm (20.00")	Tool Life	30 holes	60 holes
Tolerance:	+/- 0.127 mm (0.005")	T-A Pro offered <b>58.82%</b> cost per hole savings over the competitor tooling.		
Required Surface Finish:	3.2 µm (125 Ra µin)			

▶ T-A Pro holder  
Item No. **HTA3D15-40FM**

▶ T-A Pro insert  
M geometry (stainless steel)  
Item No. **TAM3-44.45**

45.60%  
cycle time decrease



The ISO-specific AM460 coated T-A Pro insert provided:

- ✓ Increased tool life.
- ✓ Decreased cycle time.
- ✓ Decreased cost per hole.
- ✓ Increased penetration rate.





Case Study

**Need a solution with better tool life?**

Our customer was machining engine block parts from ductile cast iron in a production cell. The replaceable tip drill they were using wasn't providing the results they needed, so they began searching for a tooling solution that would decrease machine downtime and increase productivity.

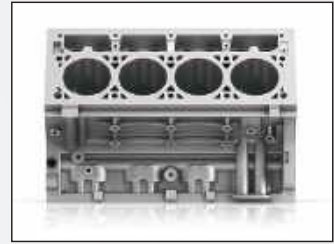

The customer tested the **T-A Pro® high penetration replaceable insert drill** using the "K" (cast iron) geometry insert with Allied's multilayer TiAlN coating that provides increased abrasion resistance and tool life. The T-A Pro performed better than the customer had hoped.

Using the T-A Pro not only provided substantial tool life improvements, but it also increased the penetration rate by 30%. The previous tooling had a tool life of 1700 holes, but the T-A Pro increased that life to 3400 holes. This allowed the customer to increase their productivity.

**In conclusion: Our customer was able to achieve £50k in tool savings per year with massive improvements in throughput.** The advantage of the T-A Pro allowed our customer to achieve their tooling goals.

	Measure	Competitor Replaceable Insert Drill	T-A Pro Drill
<b>Product:</b> T-A Pro	RPM	1819 RPM	2092 RPM
<b>Objectives:</b> (1) Decrease machine downtime (2) Increase productivity	Speed	91 m/min (300 SFM)	105 m/min (345 SFM)
<b>Industry:</b> Automotive	Feed Rate	0.20 mm/rev (0.008 IPR)	0.23 mm/rev (0.0092 IPR)
<b>Part:</b> Engine block	Penetration Rate	369.57 mm/min (14.55 IPM)	488.95 mm/min (19.25 IPM)
<b>Material:</b> Ductile cast iron	Cycle Time	39 seconds	29 seconds
<b>Hole Ø:</b> 16.00 mm (0.6299")	Tool Life	1700 holes	3400 holes
<b>Hole Depth:</b> 241.00 mm (9.50")			

- ▶ T-A Pro Drill holder  
15xD length  
**Item No. HTA0C15-20FM**
- ▶ T-A Pro Drill inserts  
K geometry  
(cast iron)  
**Item No. TAK0-16.00**

*increased tool life by 100%*









**The cast iron TiAlN coated T-A Pro insert provided:**

- ✓ Doubled tool life.
- ✓ Decreased machine downtime.
- ✓ Increased productivity.
- ✓ 30% increased penetration rate.
- ✓ Increased tool savings per year.

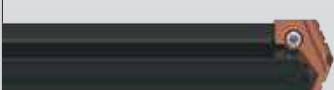

## Insert Comparison and Assembly Information

				
		T-A Pro® Inserts	GEN2 T-A® Inserts	T-A® Inserts
<b>A</b>				
DRILLING				
	Recommended for increased productivity		<input checked="" type="checkbox"/>	
<b>B</b>	ISO-specific geometry/coating combination		<input checked="" type="checkbox"/>	
BORING				
	Connects with T-A Pro holders		<input checked="" type="checkbox"/>	<input checked="" type="checkbox"/>
<b>C</b>	Connects with T-A holders		<input checked="" type="checkbox"/>	<input checked="" type="checkbox"/>
REAMING				

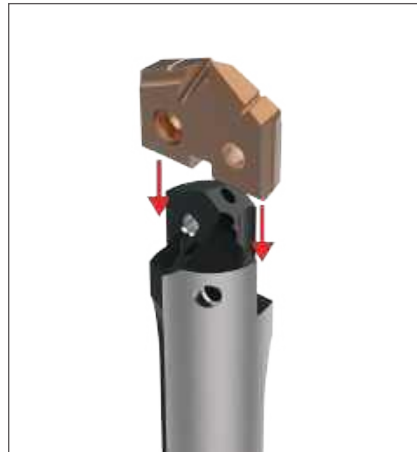

**Step 1:** Align the flats on the T-A Pro insert with the flats on the ears of the holder.

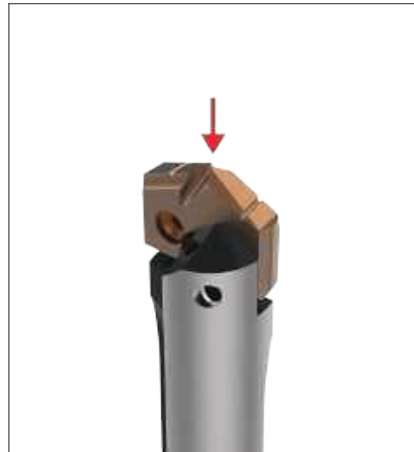

**Step 2:** Slide the insert into the precision ground locating pocket on the holder. The insert should not be turned, rotated, or twisted for locking purposes. The holder pocket and locating pads on the insert assure optimum fit and repeatability.

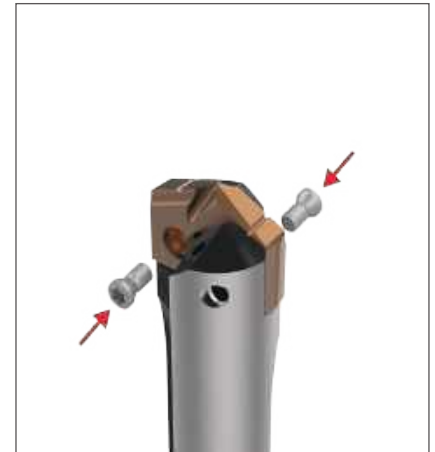

**Step 3:** Apply a generous amount of E-Z Break® (provided in the packaging) onto the supplied TORX® Plus screws.

Tighten the TORX Plus screws to the recommended torque value specified in the catalogue by series. A preset TORX driver is available to assure that the proper torque is applied.

A  
DRILLING  
B  
BORING  
C  
REAMING  
D  
BURNISHING  
E  
THREADING  
X  
SPECIALS

## T-A Pro Drilling System Information

### T-A Pro Drill Inserts



#### Carbide Geometries

##### P - Steels

- Designed to provide increased penetration rates and tool life in steel applications
- Superior geometry and edge provides excellent chip control
- Allied's multilayer AM300® coating increases heat resistance and improves tool life



##### K - Cast Irons

- Uniquely designed for cast/nodular iron applications
- Geometry developed for maximum tool life, reduced exit burr and improved hole finish
- The multilayer TiAlN coating provides increased abrasion resistance and tool life



##### N - Nonferrous Materials

- Designed for applications in aluminium, brass and copper
- The geometry yields excellent chip control in these softer materials
- TiCN coating gives the versatility to run in a variety of materials while reducing buildup



##### M - Stainless Steel\*

- Designed for all stainless steels and heat-resistant superalloys
- Geometry optimised for improved chip formation while minimising exit burr
- Allied's new AM460 coating provides industry-leading tool life in stainless and HRSA materials



\*Available in Z -3 series only.

#### Advanced Design Capabilities

The advanced T-A Pro insert combines a coating and geometry specifically designed to achieve optimal results in ISO material drilling applications. With quick connectivity to existing T-A drill insert holders, the T-A Pro insert can be interchanged with previous T-A inserts with ease, resulting in minimal setup times so you can immediately increase your productivity.

#### T-A Pro inserts connect with:



T-A Pro holders



T-A holders

#### High-Speed Steel Geometries

##### X - High-Speed Steel Materials

- Improved chip geometry for excellent chip control in all materials
- Long tool life and high-process security for the most challenging applications
- Allied's multilayer AM200® coating combines excellent heat resistance and high lubricity for wide application use



#### NEW point geometry

#### NEW flute design for increased chip evacuation



T-A Pro Drill Holders



Straight flutes.



Proprietary coolant outlets improve coolant flow.



Provides increased insert life.

Stub, 3xD, 5xD, 7xD, 10xD, 12xD, 15xD

Available in Stub, 3xD, 5xD, 7xD, 10xD, 12xD and 15xD.



**Product Nomenclature**

A  
DRILLING  
B  
BORING  
C  
REAMING  
D  
BURNISHING  
E  
THREADING  
X  
SPECIALS

**T-A Pro Drill Inserts**

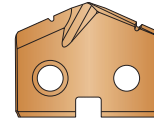

<b>TA</b>	<b>P</b>	<b>0</b>	-	<b>15.00</b>
1	2	3		4

1. T-A Pro Drill Insert	2. ISO Material / Geometry	3. Series	4. Diameter (mm)
TA = T-A Pro insert	<p><b>P</b> = Steel</p> <p><b>K</b> = Cast iron</p> <p><b>N</b> = Nonferrous</p> <p><b>M</b> = Stainless Steel*</p> <p><b>X</b> = HSS</p>	<p><b>Y</b> = Y series</p> <p><b>Z</b> = Z series</p> <p><b>0</b> = 0 series</p> <p><b>1</b> = 1 series</p> <p><b>2</b> = 2 series</p> <p><b>3</b> = 3 series</p>	For complete list of diameter ranges by series, see contents page.

\*Available in Z-3 series only.

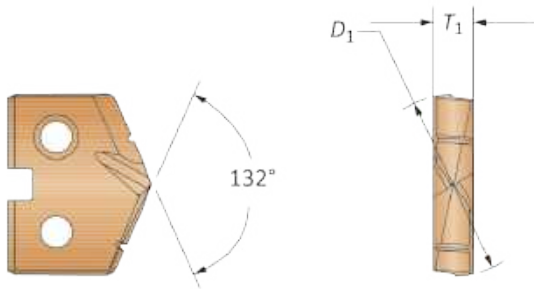

**Reference Key**

Symbol	Attribute
$D_1$	Insert diameter
$T_1$	Insert thickness



**Product Nomenclature**

**T-A Pro Drill Holders**

<b>HTA</b>	<b>0</b>	<b>B</b>	<b>05</b>	-	<b>20</b>	<b>FM</b>
1	2	3	4		5	6

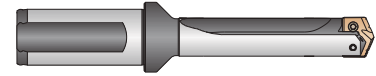

<p><b>1. Holder</b></p> <p>HTA = T-A Pro holder</p>	<p><b>2. Series</b></p> <p>Y = Y Series</p> <p>Z = Z Series</p> <p>0 = 0 Series</p> <p>1 = 1 Series</p> <p>2 = 2 Series</p> <p>3 = 3 Series</p>	<p><b>3. Body Diameter</b></p> <p>A = A body diameter</p> <p>B = B body diameter</p> <p>C = C body diameter</p> <p>D = D body diameter</p>	<p><b>4. Length</b></p> <p>01 = Stub Length</p> <p>03 = 3x Diameter</p> <p>05 = 5x Diameter</p> <p>07 = 7x Diameter</p> <p>10 = 10x Diameter</p> <p>12 = 12x Diameter</p> <p>15 = 15x Diameter</p>
---	---	--	--

<b>5. Shank Diameter</b>	
<b>Metric (mm)</b>	<b>Imperial (inch)</b>
20 = 20 mm	075 = 3/4"
25 = 25 mm	100 = 1"
32 = 32 mm	125 = 1-1/4"
40 = 40 mm	150 = 1-1/2"

<b>6. Shank Style</b>	
F = Flanged with flat	
FM = Flanged metric with flat	
C = Cylindrical (no flat)	
CM = Cylindrical metric (no flat)	

**Holder Ordering Information**

The series designator (Z series, 0 series, etc.) in the top corner of each page is for your reference when ordering. Please refer to these series designators when placing an order. For example, a Z series drill insert only fits into a Z series holder.

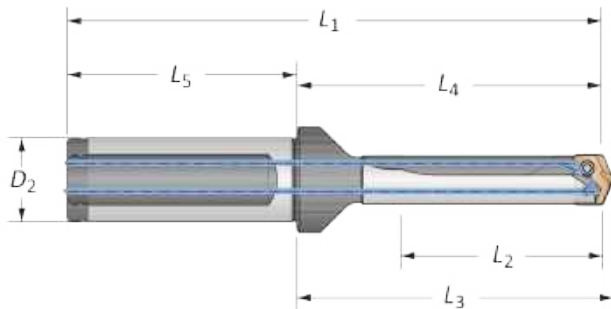

**Reference Key**

Symbol	Attribute
D <sub>2</sub>	Shank diameter
L <sub>1</sub>	Overall length
L <sub>2</sub>	Drill depth
L <sub>3</sub>	Holder reference length
L <sub>4</sub>	Holder body length
L <sub>5</sub>	Shank length

A

DRILLING

B

BORING

C

REAMING

D

BURNISHING

F

THREADING

X

SPECIALS

## T-A Pro Drill Inserts

Y Series | Diameter Range: 9.50 mm - 11.09 mm (0.3739" - 0.4368")



132°

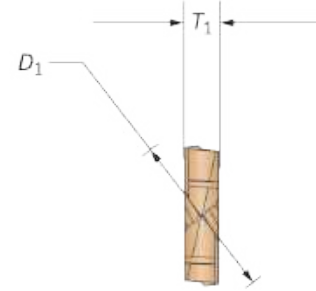

Series	$D_1$ mm	$D_1$ inch	Fractional Equivalent	$T_1$	Carbide			HSS
					Part No. P	Part No. K	Part No. N	Part No. X
Y-A	9.50	0.3740	—	3/32	TAPY-9.50	TAKY-9.50	TANY-9.50	TAXY-9.50
Y-A	9.53	0.3752	3/8	3/32	TAPY-9.53	TAKY-9.53	TANY-9.53	TAXY-9.53
Y-A	9.60	0.3780	—	3/32	TAPY-9.60	TAKY-9.60	TANY-9.60	TAXY-9.60
Y-A	9.70	0.3819	—	3/32	TAPY-9.70	TAKY-9.70	TANY-9.70	TAXY-9.70
Y-A	9.80	0.3858	—	3/32	TAPY-9.80	TAKY-9.80	TANY-9.80	TAXY-9.80
Y-A	9.90	0.3898	—	3/32	TAPY-9.90	TAKY-9.90	TANY-9.90	TAXY-9.90
Y-A	9.92	0.3906	25/64	3/32	TAPY-9.92	TAKY-9.92	TANY-9.92	TAXY-9.92
Y-A	10.00	0.3937	—	3/32	TAPY-10.00	TAKY-10.00	TANY-10.00	TAXY-10.00
Y-A	10.10	0.3976	—	3/32	TAPY-10.10	TAKY-10.10	TANY-10.10	TAXY-10.10
Y-A	10.20	0.4016	—	3/32	TAPY-10.20	TAKY-10.20	TANY-10.20	TAXY-10.20
Y-A	10.30	0.4055	—	3/32	TAPY-10.30	TAKY-10.30	TANY-10.30	TAXY-10.30

Inserts sold in multiples of 2.

### Sub Series Holders (A, B, C, D)

Sub series holders are recommended when running carbide inserts toward the upper end of the series drill range, as well as in tougher applications requiring more insert support and holder strength. **NOTE:** Only specified sub series inserts should be used with equivalent or smaller sub series holders.



A Series Insert +  
A Series Holder



C Series Insert +  
A Series Holder



C Series Insert +  
C Series Holder



A Series Insert +  
C Series Holder

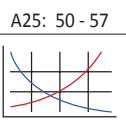
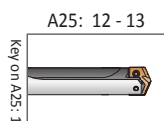

Key on A25: 1

Sizes not shown are available upon request.

When ordering, please follow the example below:

<b>Metric:</b>	13.16 mm, steel, 0 series = use Part No. <b>TAP0-13.16</b>
<b>Imperial:</b>	0.5180", steel, 0 series = use Part No. <b>TAP0-13.16</b>



## T-A Pro Drill Inserts

Y Series | Diameter Range: 9.50 mm - 11.09 mm (0.3739" - 0.4368")

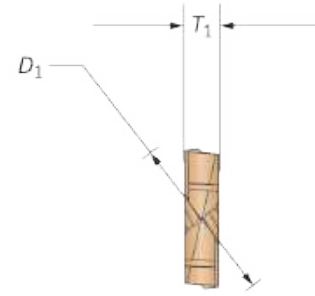

Series	Insert				Carbide			HSS
	$D_1$ mm	$D_1$ inch	Fractional Equivalent	$T_1$	Part No. P	Part No. K	Part No. N	Part No. X
Y-B	10.32	0.4063	13/32	3/32	TAPY-10.32	TAKY-10.32	TANY-10.32	TAXY-10.32
Y-B	10.40	0.4094	—	3/32	TAPY-10.40	TAKY-10.40	TANY-10.40	TAXY-10.40
Y-B	10.50	0.4134	—	3/32	TAPY-10.50	TAKY-10.50	TANY-10.50	TAXY-10.50
Y-B	10.60	0.4173	—	3/32	TAPY-10.60	TAKY-10.60	TANY-10.60	TAXY-10.60
Y-B	10.70	0.4213	—	3/32	TAPY-10.70	TAKY-10.70	TANY-10.70	TAXY-10.70
Y-B	10.72	0.4220	27/64	3/32	TAPY-10.72	TAKY-10.72	TANY-10.72	TAXY-10.72
Y-B	10.80	0.4252	—	3/32	TAPY-10.80	TAKY-10.80	TANY-10.80	TAXY-10.80
Y-B	10.90	0.4291	—	3/32	TAPY-10.90	TAKY-10.90	TANY-10.90	TAXY-10.90
Y-B	11.00	0.4331	—	3/32	TAPY-11.00	TAKY-11.00	TANY-11.00	TAXY-11.00

Inserts sold in multiples of 2.

### Sub Series Holders (A, B, C, D)

Sub series holders are recommended when running carbide inserts toward the upper end of the series drill range, as well as in tougher applications requiring more insert support and holder strength. **NOTE:** Only specified sub series inserts should be used with equivalent or smaller sub series holders.



A Series Insert +  
A Series Holder



C Series Insert +  
A Series Holder



C Series Insert +  
C Series Holder



A Series Insert +  
C Series Holder

A25: 12 - 13

A25: 50 - 57

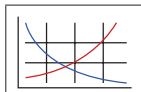
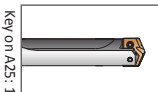

Key on A25: 1

Sizes not shown are available upon request.

When ordering, please follow the example below:

<b>Metric:</b>	13.16 mm, steel, 0 series = use Part No. <b>TAP0-13.16</b>
<b>Imperial:</b>	0.5180", steel, 0 series = use Part No. <b>TAP0-13.16</b>

## T-A Pro Drill Holders

Y Series Metric | Diameter Range: 9.50 mm - 11.09 mm

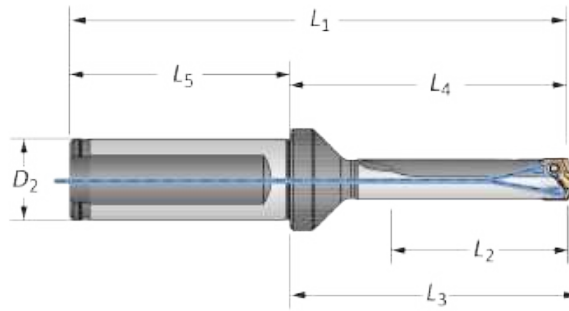

		Body				Shank				
Length	Sub Series	L <sub>2</sub>	L <sub>4</sub>	L <sub>3</sub>	L <sub>1</sub>	L <sub>5</sub>	D <sub>2</sub>	Flat	Part No.	
Stub	A	11.1	39.5	41.5	89.5	50.0	20	Yes	HTAYA01-20FM	
Stub	A	11.1	39.5	41.5	89.5	50.0	20	No	HTAYA01-20CM	
Stub	B	11.1	39.5	41.5	89.5	50.0	20	Yes	HTAYB01-20FM	
Stub	B	11.1	39.5	41.5	89.5	50.0	20	No	HTAYB01-20CM	
3xD	A	33.2	64.9	66.9	114.9	50.0	20	Yes	HTAYA03-20FM	
3xD	A	33.2	64.9	66.9	114.9	50.0	20	No	HTAYA03-20CM	
3xD	B	33.2	64.9	66.9	114.9	50.0	20	Yes	HTAYB03-20FM	
3xD	B	33.2	64.9	66.9	114.9	50.0	20	No	HTAYB03-20CM	
5xD	A	55.4	87.0	89.1	137.1	50.0	20	Yes	HTAYA05-20FM	
5xD	A	55.4	87.0	89.1	137.1	50.0	20	No	HTAYA05-20CM	
5xD	B	55.4	87.0	89.1	137.1	50.0	20	Yes	HTAYB05-20FM	
5xD	B	55.4	87.0	89.1	137.1	50.0	20	No	HTAYB05-20CM	
7xD	A	77.5	109.2	111.2	159.2	50.0	20	Yes	HTAYA07-20FM	
7xD	A	77.5	109.2	111.2	159.2	50.0	20	No	HTAYA07-20CM	
7xD	B	77.5	109.2	111.2	159.2	50.0	20	Yes	HTAYB07-20FM	
7xD	B	77.5	109.2	111.2	159.2	50.0	20	No	HTAYB07-20CM	
10xD	A	110.7	142.4	144.4	192.4	50.0	20	Yes	HTAYA10-20FM	
10xD	A	110.7	142.4	144.4	192.4	50.0	20	No	HTAYA10-20CM	
10xD	B	110.7	142.4	144.4	192.4	50.0	20	Yes	HTAYB10-20FM	
10xD	B	110.7	142.4	144.4	192.4	50.0	20	No	HTAYB10-20CM	
12xD	A	132.9	164.6	166.6	214.6	50.0	20	Yes	HTAYA12-20FM	
12xD	A	132.9	164.6	166.6	214.6	50.0	20	No	HTAYA12-20CM	
12xD	B	132.9	164.6	166.6	214.6	50.0	20	Yes	HTAYB12-20FM	
12xD	B	132.9	164.6	166.6	214.6	50.0	20	No	HTAYB12-20CM	
15xD	A	166.1	197.8	199.8	247.8	50.0	20	Yes	HTAYA15-20FM	
15xD	A	166.1	197.8	199.8	247.8	50.0	20	No	HTAYA15-20CM	
15xD	B	166.1	197.8	199.8	247.8	50.0	20	Yes	HTAYB15-20FM	
15xD	B	166.1	197.8	199.8	247.8	50.0	20	No	HTAYB15-20CM	

Ⓜ = Metric (mm)  
Ⓜ = Imperial (in)

### Connection Accessories

Sub Series	Y Series Holder Diameter Range	
	Metric (mm)	Imperial (inch)
YA	9.50 mm - 11.09 mm	0.3739" - 0.4368"
YB	10.32 mm - 11.09 mm	0.4062" - 0.4368"

Insert Screws	Nylon Locking Screws	Insert Driver	Preset Torque Hand Driver	Replacement Tips	Admissible Tightening Torque*
724-IP7-1	724N-IP7-1	8IP-7	8IP-7TL	8IP-7B	84 N-cm (7.4 in-lbs)

\*Tightening torques are calculated with a friction coefficient of  $\mu = 0.14$  and develop 90% of ultimate yield strength.

**1. WARNING** Refer to Speed and Feed charts for recommended adjustments to speeds and feeds. Refer to page A25: 60 for deep hole drilling guidelines in this section of the catalogue. Visit [www.alliedmachine.com/DeepHoleGuidelines](http://www.alliedmachine.com/DeepHoleGuidelines) for the most up-to-date information and procedures. Factory technical assistance is available for your specific applications through our Application Engineering department.  
email: [engineering.eu@alliedmachine.com](mailto:engineering.eu@alliedmachine.com)

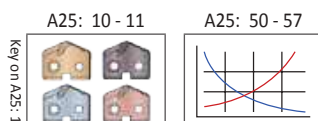

Ⓜ = Metric (mm)  
Ⓜ = Imperial (in)

Screws sold in multiples of 10.





### T-A Pro Drill Holders

Y Series Imperial | Diameter Range: 0.3739" - 0.4368"

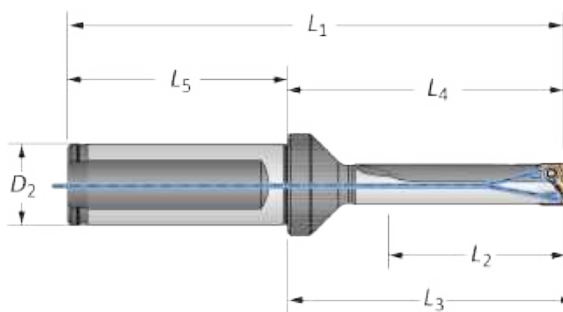

Length	Sub Series	Body				Shank			Flat	Part No.
		L <sub>2</sub>	L <sub>4</sub>	L <sub>3</sub>	L <sub>1</sub>	L <sub>5</sub>	D <sub>2</sub>			
Stub	A	0.436	1.554	1.634	3.584	2.030	3/4	Yes	HTAYA01-075F	
Stub	A	0.436	1.554	1.634	3.584	2.030	3/4	No	HTAYA01-075C	
Stub	B	0.436	1.554	1.634	3.584	2.030	3/4	Yes	HTAYB01-075F	
Stub	B	0.436	1.554	1.634	3.584	2.030	3/4	No	HTAYB01-075C	
3xD	A	1.308	2.555	2.635	4.585	2.030	3/4	Yes	HTAYA03-075F	
3xD	A	1.308	2.555	2.635	4.585	2.030	3/4	No	HTAYA03-075C	
3xD	B	1.308	2.555	2.635	4.585	2.030	3/4	Yes	HTAYB03-075F	
3xD	B	1.308	2.555	2.635	4.585	2.030	3/4	No	HTAYB03-075C	
5xD	A	2.180	3.427	3.507	5.457	2.030	3/4	Yes	HTAYA05-075F	
5xD	A	2.180	3.427	3.507	5.457	2.030	3/4	No	HTAYA05-075C	
5xD	B	2.180	3.427	3.507	5.457	2.030	3/4	Yes	HTAYB05-075F	
5xD	B	2.180	3.427	3.507	5.457	2.030	3/4	No	HTAYB05-075C	
7xD	A	3.052	4.299	4.379	6.329	2.030	3/4	Yes	HTAYA07-075F	
7xD	A	3.052	4.299	4.379	6.329	2.030	3/4	No	HTAYA07-075C	
7xD	B	3.052	4.299	4.379	6.329	2.030	3/4	Yes	HTAYB07-075F	
7xD	B	3.052	4.299	4.379	6.329	2.030	3/4	No	HTAYB07-075C	
10xD	A	4.360	5.607	5.687	7.637	2.030	3/4	Yes	HTAYA10-075F	
10xD	A	4.360	5.607	5.687	7.637	2.030	3/4	No	HTAYA10-075C	
10xD	B	4.360	5.607	5.687	7.637	2.030	3/4	Yes	HTAYB10-075F	
10xD	B	4.360	5.607	5.687	7.637	2.030	3/4	No	HTAYB10-075C	
12xD	A	5.232	6.479	6.559	8.509	2.030	3/4	Yes	HTAYA12-075F	
12xD	A	5.232	6.479	6.559	8.509	2.030	3/4	No	HTAYA12-075C	
12xD	B	5.232	6.479	6.559	8.509	2.030	3/4	Yes	HTAYB12-075F	
12xD	B	5.232	6.479	6.559	8.509	2.030	3/4	No	HTAYB12-075C	
15xD	A	6.540	7.787	7.867	9.817	2.030	3/4	Yes	HTAYA15-075F	
15xD	A	6.540	7.787	7.867	9.817	2.030	3/4	No	HTAYA15-075C	
15xD	B	6.540	7.787	7.867	9.817	2.030	3/4	Yes	HTAYB15-075F	
15xD	B	6.540	7.787	7.867	9.817	2.030	3/4	No	HTAYB15-075C	

1

#### Connection Accessories

Sub Series	Y Series Holder Diameter Range	
	Metric (mm)	Imperial (inch)
YA	9.50 mm - 11.09 mm	0.3739" - 0.4368"
YB	10.32 mm - 11.09 mm	0.4062" - 0.4368"

Insert Screws	Nylon Locking Screws	Insert Driver	Preset Torque Hand Driver	Replacement Tips	Admissible Tightening Torque*
724-IP7-1	724N-IP7-1	8IP-7	8IP-7TL	8IP-7B	84 N-cm (7.4 in-lbs)

\*Tightening torques are calculated with a friction coefficient of  $\mu = 0.14$  and develop 90% of ultimate yield strength.

**1. WARNING** Refer to Speed and Feed charts for recommended adjustments to speeds and feeds. Refer to page A25: 60 for deep hole drilling guidelines in this section of the catalogue. Visit [www.alliedmachine.com/DeepHoleGuidelines](http://www.alliedmachine.com/DeepHoleGuidelines) for the most up-to-date information and procedures. Factory technical assistance is available for your specific applications through our Application Engineering department.  
email: [engineering.eu@alliedmachine.com](mailto:engineering.eu@alliedmachine.com)

A25: 10 - 11      A25: 50 - 57

Ⓜ = Metric (mm)  
Ⓜ = Imperial (in)





Screws sold in multiples of 10.

A DRILLING  
B BORING  
C REAMING  
D BURNISHING  
E THREADING  
X SPECIALS

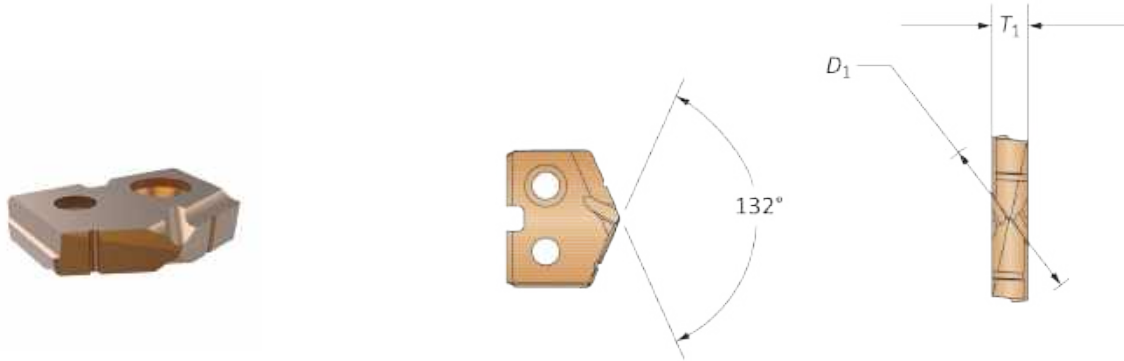
## T-A Pro Drill Inserts

Z Series | Diameter Range: 11.10 mm - 12.69 mm (0.4369" - 0.4998")



Insert					Carbide				HSS
Series	$D_1$ mm	$D_1$ inch	Fractional Equivalent	$T_1$					
					Part No.	Part No.	Part No.	Part No.	Part No.
					P	K	N	M	X
Z-A	11.11	0.4374	7/16	3/32	TAPZ-11.11	TAKZ-11.11	TANZ-11.11	TAMZ-11.11	TAXZ-11.11
Z-A	11.20	0.4409	—	3/32	TAPZ-11.20	TAKZ-11.20	TANZ-11.20	TAMZ-11.20	TAXZ-11.20
Z-A	11.30	0.4449	—	3/32	TAPZ-11.30	TAKZ-11.30	TANZ-11.30	TAMZ-11.30	TAXZ-11.30
Z-A	11.40	0.4488	—	3/32	TAPZ-11.40	TAKZ-11.40	TANZ-11.40	TAMZ-11.40	TAXZ-11.40
Z-A	11.50	0.4528	—	3/32	TAPZ-11.50	TAKZ-11.50	TANZ-11.50	TAMZ-11.50	TAXZ-11.50
Z-A	11.51	0.4531	29/64	3/32	TAPZ-11.51	TAKZ-11.51	TANZ-11.51	TAMZ-11.51	TAXZ-11.51
Z-A	11.60	0.4567	—	3/32	TAPZ-11.60	TAKZ-11.60	TANZ-11.60	TAMZ-11.60	TAXZ-11.60
Z-A	11.70	0.4606	—	3/32	TAPZ-11.70	TAKZ-11.70	TANZ-11.70	TAMZ-11.70	TAXZ-11.70
Z-A	11.80	0.4646	—	3/32	TAPZ-11.80	TAKZ-11.80	TANZ-11.80	TAMZ-11.80	TAXZ-11.80
Z-A	11.91	0.4689	15/32	3/32	TAPZ-11.91	TAKZ-11.91	TANZ-11.91	TAMZ-11.91	TAXZ-11.91
Z-A	12.00	0.4724	—	3/32	TAPZ-12.00	TAKZ-12.00	TANZ-12.00	TAMZ-12.00	TAXZ-12.00
Z-A	12.10	0.4764	—	3/32	TAPZ-12.10	TAKZ-12.10	TANZ-12.10	TAMZ-12.10	TAXZ-12.10

Inserts sold in multiples of 2.

### Sub Series Holders (A, B, C, D)

Sub series holders are recommended when running carbide inserts toward the upper end of the series drill range, as well as in tougher applications requiring more insert support and holder strength. **NOTE:** Only specified sub series inserts should be used with equivalent or smaller sub series holders.



A Series Insert +  
A Series Holder



C Series Insert +  
A Series Holder



C Series Insert +  
C Series Holder



A Series Insert +  
C Series Holder

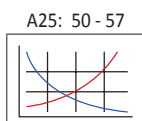
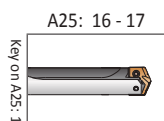

Sizes not shown are available upon request.  
When ordering, please follow the example below:





<b>Metric:</b>	13.16 mm, steel, 0 series = use Part No. <b>TAP0-13.16</b>
<b>Imperial:</b>	0.5180", steel, 0 series = use Part No. <b>TAP0-13.16</b>

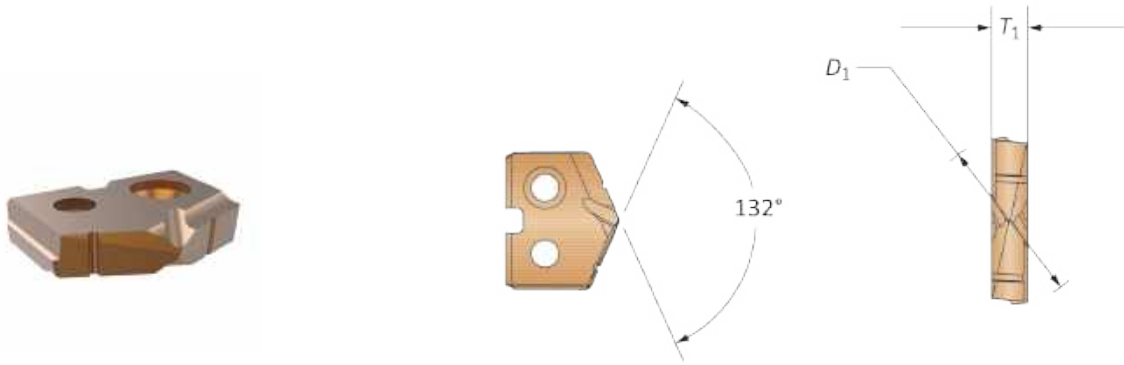

### T-A Pro Drill Inserts

Z Series | Diameter Range: 11.10 mm - 12.69 mm (0.4369" - 0.4998")



Insert					Carbide				HSS
Series	D <sub>1</sub> mm	D <sub>1</sub> inch	Fractional Equivalent	T <sub>1</sub>					
					Part No.	Part No.	Part No.	Part No.	Part No.
					P	K	N	M	X
Z-B	12.20	0.4803	—	3/32	TAPZ-12.20	TAKZ-12.20	TANZ-12.20	TAMZ-12.20	TAXZ-12.20
Z-B	12.30	0.4843	31/64	3/32	TAPZ-12.30	TAKZ-12.30	TANZ-12.30	TAMZ-12.30	TAXZ-12.30
Z-B	12.40	0.4882	—	3/32	TAPZ-12.40	TAKZ-12.40	TANZ-12.40	TAMZ-12.40	TAXZ-12.40
Z-B	12.50	0.4921	—	3/32	TAPZ-12.50	TAKZ-12.50	TANZ-12.50	TAMZ-12.50	TAXZ-12.50
Z-B	12.60	0.4961	—	3/32	TAPZ-12.60	TAKZ-12.60	TANZ-12.60	TAMZ-12.60	TAXZ-12.60

Inserts sold in multiples of 2.

A

DRILLING

B

BORING

C

REAMING

D

BURNISHING

F

THREADING

X

SPECIALS

#### Sub Series Holders (A, B, C, D)

Sub series holders are recommended when running carbide inserts toward the upper end of the series drill range, as well as in tougher applications requiring more insert support and holder strength. **NOTE:** Only specified sub series inserts should be used with equivalent or smaller sub series holders.



A Series Insert +  
A Series Holder



C Series Insert +  
A Series Holder



C Series Insert +  
C Series Holder



A Series Insert +  
C Series Holder

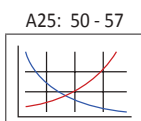
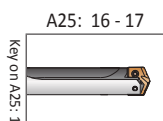

Sizes not shown are available upon request.	
When ordering, please follow the example below:	
<b>Metric:</b>	13.16 mm, steel, 0 series = use Part No. <b>TAP0-13.16</b>
<b>Imperial:</b>	0.5180", steel, 0 series = use Part No. <b>TAP0-13.16</b>

## T-A Pro Drill Holders

Z Series Metric | Diameter Range: 11.10 mm - 12.69 mm

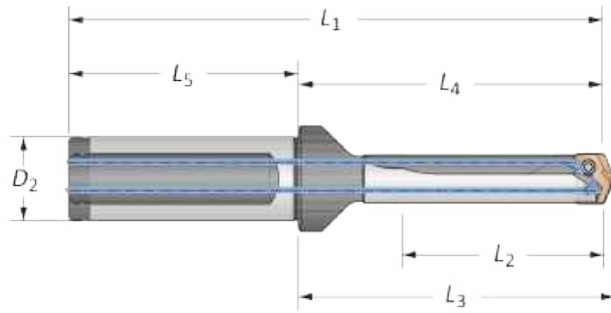

		Body				Shank				
Length	Sub Series	L <sub>2</sub>	L <sub>4</sub>	L <sub>3</sub>	L <sub>1</sub>	L <sub>5</sub>	D <sub>2</sub>	Flat	Part No.	
Stub	A	12.0	40.6	42.7	90.7	50.0	20	Yes	HTAZA01-20FM	
Stub	A	12.0	40.6	42.7	90.7	50.0	20	No	HTAZA01-20CM	
Stub	B	12.0	40.6	42.7	90.7	50.0	20	Yes	HTAZB01-20FM	
Stub	B	12.0	40.6	42.7	90.7	50.0	20	No	HTAZB01-20CM	
3xD	A	36.1	68.4	70.4	118.4	50.0	20	Yes	HTAZA03-20FM	
3xD	A	36.1	68.4	70.4	118.4	50.0	20	No	HTAZA03-20CM	
3xD	B	36.1	68.4	70.4	118.4	50.0	20	Yes	HTAZB03-20FM	
3xD	B	36.1	68.4	70.4	118.4	50.0	20	No	HTAZB03-20CM	
5xD	A	60.2	92.5	94.5	142.5	50.0	20	Yes	HTAZA05-20FM	
5xD	A	60.2	92.5	94.5	142.5	50.0	20	No	HTAZA05-20CM	
5xD	B	60.2	92.5	94.5	142.5	50.0	20	Yes	HTAZB05-20FM	
5xD	B	60.2	92.5	94.5	142.5	50.0	20	No	HTAZB05-20CM	
7xD	A	84.3	116.6	118.6	166.6	50.0	20	Yes	HTAZA07-20FM	
7xD	A	84.3	116.6	118.6	166.6	50.0	20	No	HTAZA07-20CM	
7xD	B	84.3	116.6	118.6	166.6	50.0	20	Yes	HTAZB07-20FM	
7xD	B	84.3	116.6	118.6	166.6	50.0	20	No	HTAZB07-20CM	
10xD	A	120.4	152.7	154.7	202.7	50.0	20	Yes	HTAZA10-20FM	
10xD	A	120.4	152.7	154.7	202.7	50.0	20	No	HTAZA10-20CM	
10xD	B	120.4	152.7	154.7	202.7	50.0	20	Yes	HTAZB10-20FM	
10xD	B	120.4	152.7	154.7	202.7	50.0	20	No	HTAZB10-20CM	
12xD	A	144.5	176.8	178.8	226.8	50.0	20	Yes	HTAZA12-20FM	
12xD	A	144.5	176.8	178.8	226.8	50.0	20	No	HTAZA12-20CM	
12xD	B	144.5	176.8	178.8	226.8	50.0	20	Yes	HTAZB12-20FM	
12xD	B	144.5	176.8	178.8	226.8	50.0	20	No	HTAZB12-20CM	
15xD	A	180.6	212.9	214.9	262.9	50.0	20	Yes	HTAZA15-20FM	
15xD	A	180.6	212.9	214.9	262.9	50.0	20	No	HTAZA15-20CM	
15xD	B	180.6	212.9	214.9	262.9	50.0	20	Yes	HTAZB15-20FM	
15xD	B	180.6	212.9	214.9	262.9	50.0	20	No	HTAZB15-20CM	

Ⓜ = Metric (mm)  
Ⓜ = Imperial (in)

Sub Series	Z Series Holder Diameter Range	
	Metric (mm)	Imperial (inch)
ZA	11.10 mm - 12.69 mm	0.4369" - 0.4998"
ZB	12.20 mm - 12.69 mm	0.4802" - 0.4998"

### Connection Accessories

Insert Screws	Nylon Locking Screws	Insert Driver	Preset Torque Hand Driver	Replacement Tips	Admissible Tightening Torque*
7247-IP7-1	7247N-IP7-1	8IP-7	8IP-7TL	8IP-7B	84 N-cm (7.4 in-lbs)

\*Tightening torques are calculated with a friction coefficient of  $\mu = 0.14$  and develop 90% of ultimate yield strength.

**⚠ WARNING** Refer to Speed and Feed charts for recommended adjustments to speeds and feeds. Refer to page **A25: 60** for deep hole drilling guidelines in this section of the catalogue. Visit [www.alliedmachine.com/DeepHoleGuidelines](http://www.alliedmachine.com/DeepHoleGuidelines) for the most up-to-date information and procedures. Factory technical assistance is available for your specific applications through our Application Engineering department.  
email: [engineering.eu@alliedmachine.com](mailto:engineering.eu@alliedmachine.com)

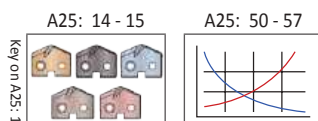

Ⓜ = Metric (mm)  
Ⓜ = Imperial (in)

Screws sold in multiples of 10.



T-A Pro Drill Holders

Z Series Imperial | Diameter Range: 0.4369" - 0.4998"

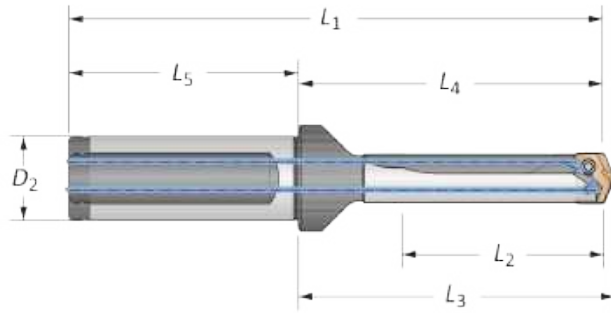

Length	Sub Series	Body				Shank			Flat	Part No.
		L <sub>2</sub>	L <sub>4</sub>	L <sub>3</sub>	L <sub>1</sub>	L <sub>5</sub>	D <sub>2</sub>			
Stub	A	0.474	1.600	1.680	3.630	2.030	3/4	Yes	HTAZA01-075F	
Stub	A	0.474	1.600	1.680	3.630	2.030	3/4	No	HTAZA01-075C	
Stub	B	0.474	1.600	1.680	3.630	2.030	3/4	Yes	HTAZB01-075F	
Stub	B	0.474	1.600	1.680	3.630	2.030	3/4	No	HTAZB01-075C	
3xD	A	1.422	2.693	2.773	4.723	2.030	3/4	Yes	HTAZA03-075F	
3xD	A	1.422	2.693	2.773	4.723	2.030	3/4	No	HTAZA03-075C	
3xD	B	1.422	2.693	2.773	4.723	2.030	3/4	Yes	HTAZB03-075F	
3xD	B	1.422	2.693	2.773	4.723	2.030	3/4	No	HTAZB03-075C	
5xD	A	2.370	3.641	3.721	5.671	2.030	3/4	Yes	HTAZA05-075F	
5xD	A	2.370	3.641	3.721	5.671	2.030	3/4	No	HTAZA05-075C	
5xD	B	2.370	3.641	3.721	5.671	2.030	3/4	Yes	HTAZB05-075F	
5xD	B	2.370	3.641	3.721	5.671	2.030	3/4	No	HTAZB05-075C	
7xD	A	3.318	4.589	4.669	6.619	2.030	3/4	Yes	HTAZA07-075F	
7xD	A	3.318	4.589	4.669	6.619	2.030	3/4	No	HTAZA07-075C	
7xD	B	3.318	4.589	4.669	6.619	2.030	3/4	Yes	HTAZB07-075F	
7xD	B	3.318	4.589	4.669	6.619	2.030	3/4	No	HTAZB07-075C	
10xD	A	4.740	6.011	6.091	8.041	2.030	3/4	Yes	HTAZA10-075F	
10xD	A	4.740	6.011	6.091	8.041	2.030	3/4	No	HTAZA10-075C	
10xD	B	4.740	6.011	6.091	8.041	2.030	3/4	Yes	HTAZB10-075F	
10xD	B	4.740	6.011	6.091	8.041	2.030	3/4	No	HTAZB10-075C	
12xD	A	5.688	6.959	7.039	8.989	2.030	3/4	Yes	HTAZA12-075F	
12xD	A	5.688	6.959	7.039	8.989	2.030	3/4	No	HTAZA12-075C	
12xD	B	5.688	6.959	7.039	8.989	2.030	3/4	Yes	HTAZB12-075F	
12xD	B	5.688	6.959	7.039	8.989	2.030	3/4	No	HTAZB12-075C	
15xD	A	7.110	8.381	8.461	10.411	2.030	3/4	Yes	HTAZA15-075F	
15xD	A	7.110	8.381	8.461	10.411	2.030	3/4	No	HTAZA15-075C	
15xD	B	7.110	8.381	8.461	10.411	2.030	3/4	Yes	HTAZB15-075F	
15xD	B	7.110	8.381	8.461	10.411	2.030	3/4	No	HTAZB15-075C	

1

Sub Series	Z Series Holder Diameter Range	
	Metric (mm)	Imperial (inch)
ZA	11.10 mm - 12.69 mm	0.4369" - 0.4998"
ZB	12.20 mm - 12.69 mm	0.4802" - 0.4998"

Connection Accessories

Insert Screws	Nylon Locking Screws	Insert Driver	Preset Torque Hand Driver	Replacement Tips	Admissible Tightening Torque*
7247-IP7-1	7247N-IP7-1	8IP-7	8IP-7TL	8IP-7B	84 N-cm (7.4 in-lbs)

\*Tightening torques are calculated with a friction coefficient of  $\mu = 0.14$  and develop 90% of ultimate yield strength.

**1. WARNING** Refer to Speed and Feed charts for recommended adjustments to speeds and feeds. Refer to page A25: 60 for deep hole drilling guidelines in this section of the catalogue. Visit [www.alliedmachine.com/DeepHoleGuidelines](http://www.alliedmachine.com/DeepHoleGuidelines) for the most up-to-date information and procedures. Factory technical assistance is available for your specific applications through our Application Engineering department. email: [engineering.eu@alliedmachine.com](mailto:engineering.eu@alliedmachine.com)

A25: 14 - 15      A25: 50 - 57





Ⓜ = Metric (mm)  
 ⓘ = Imperial (in)  
 Screws sold in multiples of 10.

A  
DRILLING  
B  
BORING  
C  
REAMING  
D  
BURNISHING  
E  
THREADING  
X  
SPECIALS

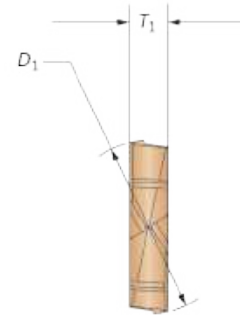
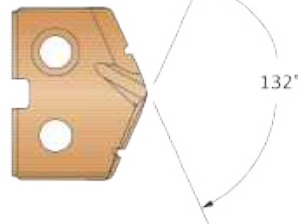
## T-A Pro Drill Inserts

0 Series | Diameter Range: 12.70 mm - 17.64 mm (0.4999" - 0.6946")



Insert					Carbide				HSS
Series	D <sub>1</sub> mm	D <sub>1</sub> inch	Fractional Equivalent	T <sub>1</sub>					
					Part No.	Part No.	Part No.	Part No.	Part No.
					P	K	N	M	X
0-A	12.70	0.5000	1/2	1/8	TAP0-12.70	TAK0-12.70	TAN0-12.70	TAM0-12.70	TAX0-12.70
0-A	12.80	0.5039	—	1/8	TAP0-12.80	TAK0-12.80	TAN0-12.80	TAM0-12.80	TAX0-12.80
0-A	12.90	0.5079	—	1/8	TAP0-12.90	TAK0-12.90	TAN0-12.90	TAM0-12.90	TAX0-12.90
0-A	13.00	0.5118	—	1/8	TAP0-13.00	TAK0-13.00	TAN0-13.00	TAM0-13.00	TAX0-13.00
0-A	13.10	0.5157	33/64	1/8	TAP0-13.10	TAK0-13.10	TAN0-13.10	TAM0-13.10	TAX0-13.10
0-A	13.20	0.5197	—	1/8	TAP0-13.20	TAK0-13.20	TAN0-13.20	TAM0-13.20	TAX0-13.20
0-A	13.30	0.5236	—	1/8	TAP0-13.30	TAK0-13.30	TAN0-13.30	TAM0-13.30	TAX0-13.30
0-A	13.40	0.5276	—	1/8	TAP0-13.40	TAK0-13.40	TAN0-13.40	TAM0-13.40	TAX0-13.40
0-A	13.49	0.5311	17/32	1/8	TAP0-13.49	TAK0-13.49	TAN0-13.49	TAM0-13.49	TAX0-13.49
0-A	13.50	0.5315	—	1/8	TAP0-13.50	TAK0-13.50	TAN0-13.50	TAM0-13.50	TAX0-13.50
0-A	13.60	0.5354	—	1/8	TAP0-13.60	TAK0-13.60	TAN0-13.60	TAM0-13.60	TAX0-13.60
0-A	13.70	0.5394	—	1/8	TAP0-13.70	TAK0-13.70	TAN0-13.70	TAM0-13.70	TAX0-13.70
0-A	13.80	0.5433	—	1/8	TAP0-13.80	TAK0-13.80	TAN0-13.80	TAM0-13.80	TAX0-13.80
0-A	13.89	0.5469	35/64	1/8	TAP0-13.89	TAK0-13.89	TAN0-13.89	TAM0-13.89	TAX0-13.89
0-B	14.00	0.5512	—	1/8	TAP0-14.00	TAK0-14.00	TAN0-14.00	TAM0-14.00	TAX0-14.00
0-B	14.10	0.5551	—	1/8	TAP0-14.10	TAK0-14.10	TAN0-14.10	TAM0-14.10	TAX0-14.10
0-B	14.20	0.5591	—	1/8	TAP0-14.20	TAK0-14.20	TAN0-14.20	TAM0-14.20	TAX0-14.20
0-B	14.29	0.5626	9/16	1/8	TAP0-14.29	TAK0-14.29	TAN0-14.29	TAM0-14.29	TAX0-14.29
0-B	14.40	0.5669	—	1/8	TAP0-14.40	TAK0-14.40	TAN0-14.40	TAM0-14.40	TAX0-14.40
0-B	14.50	0.5709	—	1/8	TAP0-14.50	TAK0-14.50	TAN0-14.50	TAM0-14.50	TAX0-14.50
0-B	14.60	0.5748	—	1/8	TAP0-14.60	TAK0-14.60	TAN0-14.60	TAM0-14.60	TAX0-14.60
0-B	14.68	0.5780	37/64	1/8	TAP0-14.68	TAK0-14.68	TAN0-14.68	TAM0-14.68	TAX0-14.68
0-B	14.80	0.5827	—	1/8	TAP0-14.80	TAK0-14.80	TAN0-14.80	TAM0-14.80	TAX0-14.80
0-B	14.90	0.5866	—	1/8	TAP0-14.90	TAK0-14.90	TAN0-14.90	TAM0-14.90	TAX0-14.90
0-B	15.00	0.5906	—	1/8	TAP0-15.00	TAK0-15.00	TAN0-15.00	TAM0-15.00	TAX0-15.00

Inserts sold in multiples of 2.

### Sub Series Holders (A, B, C, D)

Sub series holders are recommended when running carbide inserts toward the upper end of the series drill range, as well as in tougher applications requiring more insert support and holder strength. **NOTE:** Only specified sub series inserts should be used with equivalent or smaller sub series holders.



A Series Insert +  
A Series Holder



C Series Insert +  
A Series Holder



C Series Insert +  
C Series Holder



A Series Insert +  
C Series Holder

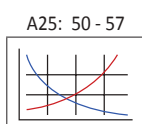
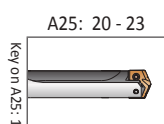

Key on A25: 1

Sizes not shown are available upon request.

When ordering, please follow the example below:

<b>Metric:</b>	13.16 mm, steel, 0 series = use Part No. <b>TAP0-13.16</b>
<b>Imperial:</b>	0.5180", steel, 0 series = use Part No. <b>TAP0-13.16</b>



T-A Pro Drill Inserts

0 Series | Diameter Range: 12.70 mm - 17.64 mm (0.4999" - 0.6946")

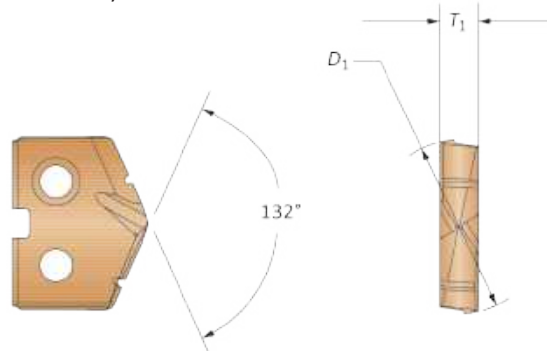

Insert					Carbide				HSS
Series	D <sub>1</sub> mm	D <sub>1</sub> inch	Fractional Equivalent	T <sub>1</sub>					
					P	K	N	M	X
0-C	15.08	0.5937	19/32	1/8	TAP0-15.08	TAK0-15.08	TAN0-15.08	TAM0-15.08	TAX0-15.08
0-C	15.20	0.5984	—	1/8	TAP0-15.20	TAK0-15.20	TAN0-15.20	TAM0-15.20	TAX0-15.20
0-C	15.25	0.6004	—	1/8	TAP0-15.25	TAK0-15.25	TAN0-15.25	TAM0-15.25	TAX0-15.25
0-C	15.30	0.6024	—	1/8	TAP0-15.30	TAK0-15.30	TAN0-15.30	TAM0-15.30	TAX0-15.30
0-C	15.40	0.6063	—	1/8	TAP0-15.40	TAK0-15.40	TAN0-15.40	TAM0-15.40	TAX0-15.40
0-C	15.48	0.6094	39/64	1/8	TAP0-15.48	TAK0-15.48	TAN0-15.48	TAM0-15.48	TAX0-15.48
0-C	15.50	0.6102	—	1/8	TAP0-15.50	TAK0-15.50	TAN0-15.50	TAM0-15.50	TAX0-15.50
0-C	15.60	0.6142	—	1/8	TAP0-15.60	TAK0-15.60	TAN0-15.60	TAM0-15.60	TAX0-15.60
0-C	15.70	0.6181	—	1/8	TAP0-15.70	TAK0-15.70	TAN0-15.70	TAM0-15.70	TAX0-15.70
0-C	15.80	0.6220	—	1/8	TAP0-15.80	TAK0-15.80	TAN0-15.80	TAM0-15.80	TAX0-15.80
0-C	15.88	0.6252	5/8	1/8	TAP0-15.88	TAK0-15.88	TAN0-15.88	TAM0-15.88	TAX0-15.88
0-C	16.00	0.6299	—	1/8	TAP0-16.00	TAK0-16.00	TAN0-16.00	TAM0-16.00	TAX0-16.00
0-C	16.08	0.6331	—	1/8	TAP0-16.08	TAK0-16.08	TAN0-16.08	TAM0-16.08	TAX0-16.08
0-C	16.20	0.6378	—	1/8	TAP0-16.20	TAK0-16.20	TAN0-16.20	TAM0-16.20	TAX0-16.20
0-C	16.27	0.6406	41/64	1/8	TAP0-16.27	TAK0-16.27	TAN0-16.27	TAM0-16.27	TAX0-16.27
0-C	16.40	0.6457	—	1/8	TAP0-16.40	TAK0-16.40	TAN0-16.40	TAM0-16.40	TAX0-16.40
0-D	16.50	0.6496	—	1/8	TAP0-16.50	TAK0-16.50	TAN0-16.50	TAM0-16.50	TAX0-16.50
0-D	16.60	0.6535	—	1/8	TAP0-16.60	TAK0-16.60	TAN0-16.60	TAM0-16.60	TAX0-16.60
0-D	16.67	0.6563	21/32	1/8	TAP0-16.67	TAK0-16.67	TAN0-16.67	TAM0-16.67	TAX0-16.67
0-D	16.80	0.6614	—	1/8	TAP0-16.80	TAK0-16.80	TAN0-16.80	TAM0-16.80	TAX0-16.80
0-D	16.90	0.6654	—	1/8	TAP0-16.90	TAK0-16.90	TAN0-16.90	TAM0-16.90	TAX0-16.90
0-D	17.00	0.6693	—	1/8	TAP0-17.00	TAK0-17.00	TAN0-17.00	TAM0-17.00	TAX0-17.00
0-D	17.07	0.6720	43/64	1/8	TAP0-17.07	TAK0-17.07	TAN0-17.07	TAM0-17.07	TAX0-17.07
0-D	17.10	0.6732	—	1/8	TAP0-17.10	TAK0-17.10	TAN0-17.10	TAM0-17.10	TAX0-17.10
0-D	17.20	0.6772	—	1/8	TAP0-17.20	TAK0-17.20	TAN0-17.20	TAM0-17.20	TAX0-17.20
0-D	17.30	0.6811	—	1/8	TAP0-17.30	TAK0-17.30	TAN0-17.30	TAM0-17.30	TAX0-17.30
0-D	17.40	0.6850	—	1/8	TAP0-17.40	TAK0-17.40	TAN0-17.40	TAM0-17.40	TAX0-17.40
0-D	17.46	0.6874	11/16	1/8	TAP0-17.46	TAK0-17.46	TAN0-17.46	TAM0-17.46	TAX0-17.46
0-D	17.50	0.6890	—	1/8	TAP0-17.50	TAK0-17.50	TAN0-17.50	TAM0-17.50	TAX0-17.50
0-D	17.60	0.6929	—	1/8	TAP0-17.60	TAK0-17.60	TAN0-17.60	TAM0-17.60	TAX0-17.60

Inserts sold in multiples of 2.

Sub Series Holders (A, B, C, D)

Sub series holders are recommended when running carbide inserts toward the upper end of the series drill range, as well as in tougher applications requiring more insert support and holder strength. **NOTE:** Only specified sub series inserts should be used with equivalent or smaller sub series holders.



A Series Insert + A Series Holder



C Series Insert + A Series Holder



C Series Insert + C Series Holder



A Series Insert + C Series Holder

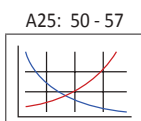
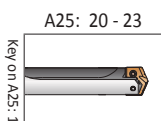

Key on A25: 1

Sizes not shown are available upon request.	
When ordering, please follow the example below:	
Metric:	13.16 mm, steel, 0 series = use Part No. <b>TAP0-13.16</b>
Imperial:	0.5180", steel, 0 series = use Part No. <b>TAP0-13.16</b>

## T-A Pro Drill Holders

0 Series Metric | Diameter Range: 12.70 mm - 17.64 mm

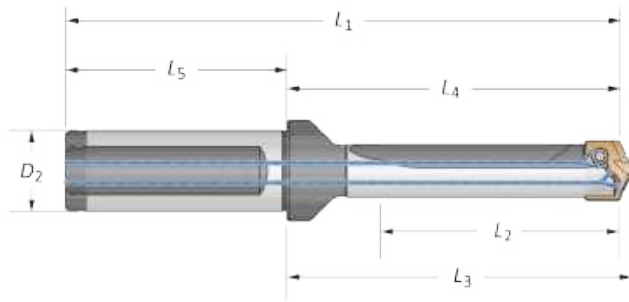

Body		Shank							
Length	Sub Series	L <sub>2</sub>	L <sub>4</sub>	L <sub>3</sub>	L <sub>1</sub>	L <sub>5</sub>	D <sub>2</sub>	Flat	Part No.
Stub	A	15.3	44.0	46.7	94.0	50.0	20	Yes	HTA0A01-20FM
Stub	A	15.3	44.0	46.7	94.0	50.0	20	No	HTA0A01-20CM
Stub	B	15.3	44.0	46.7	94.0	50.0	20	Yes	HTA0B01-20FM
Stub	B	15.3	44.0	46.7	94.0	50.0	20	No	HTA0B01-20CM
Stub	C	15.3	44.0	46.7	94.0	50.0	20	Yes	HTA0C01-20FM
Stub	C	15.3	44.0	46.7	94.0	50.0	20	No	HTA0C01-20CM
Stub	D	15.3	44.0	46.7	94.0	50.0	20	Yes	HTA0D01-20FM
Stub	D	15.3	44.0	46.7	94.0	50.0	20	No	HTA0D01-20CM
3xD	A	45.9	77.8	80.5	127.8	50.0	20	Yes	HTA0A03-20FM
3xD	A	45.9	77.8	80.5	127.8	50.0	20	No	HTA0A03-20CM
3xD	B	45.9	77.8	80.5	127.8	50.0	20	Yes	HTA0B03-20FM
3xD	B	45.9	77.8	80.5	127.8	50.0	20	No	HTA0B03-20CM
3xD	C	45.9	77.8	80.5	127.8	50.0	20	Yes	HTA0C03-20FM
3xD	C	45.9	77.8	80.5	127.8	50.0	20	No	HTA0C03-20CM
3xD	D	45.9	77.8	80.5	127.8	50.0	20	Yes	HTA0D03-20FM
3xD	D	45.9	77.8	80.5	127.8	50.0	20	No	HTA0D03-20CM
5xD	A	76.6	108.5	111.2	158.5	50.0	20	Yes	HTA0A05-20FM
5xD	A	76.6	108.5	111.2	158.5	50.0	20	No	HTA0A05-20CM
5xD	B	76.6	108.5	111.2	158.5	50.0	20	Yes	HTA0B05-20FM
5xD	B	76.6	108.5	111.2	158.5	50.0	20	No	HTA0B05-20CM
5xD	C	76.6	108.5	111.2	158.5	50.0	20	Yes	HTA0C05-20FM
5xD	C	76.6	108.5	111.2	158.5	50.0	20	No	HTA0C05-20CM
5xD	D	76.6	108.5	111.2	158.5	50.0	20	Yes	HTA0D05-20FM
5xD	D	76.6	108.5	111.2	158.5	50.0	20	No	HTA0D05-20CM
7xD	A	107.2	139.1	141.8	189.1	50.0	20	Yes	HTA0A07-20FM
7xD	A	107.2	139.1	141.8	189.1	50.0	20	No	HTA0A07-20CM
7xD	B	107.2	139.1	141.8	189.1	50.0	20	Yes	HTA0B07-20FM
7xD	B	107.2	139.1	141.8	189.1	50.0	20	No	HTA0B07-20CM
7xD	C	107.2	139.1	141.8	189.1	50.0	20	Yes	HTA0C07-20FM
7xD	C	107.2	139.1	141.8	189.1	50.0	20	No	HTA0C07-20CM
7xD	D	107.2	139.1	141.8	189.1	50.0	20	Yes	HTA0D07-20FM
7xD	D	107.2	139.1	141.8	189.1	50.0	20	No	HTA0D07-20CM

### Connection Accessories

Sub Series	0 Series Holder Diameter Range	
	Metric (mm)	Imperial (inch)
0A	12.70 mm - 17.64 mm	0.4999" - 0.6946"
0B	14.00 mm - 17.64 mm	0.5510" - 0.6946"
0C	15.08 mm - 17.64 mm	0.5936" - 0.6946"
0D	16.50 mm - 17.64 mm	0.6495" - 0.6946"

	Insert Screws	Nylon Locking Screws	Insert Driver	Preset Torque Hand Driver	Replacement Tips	Admissible Tightening Torque*
A/B	72556-IP8-1	72556N-IP8-1	8IP-8	8IP-8TL	8IP-8B	175 N-cm (15.5 in-lbs)
C/D	72567-IP8-1	72567N-IP8-1	8IP-8	8IP-8TL	8IP-8B	175 N-cm (15.5 in-lbs)

\*Tightening torques are calculated with a friction coefficient of  $\mu = 0.14$  and develop 90% of ultimate yield strength.

**WARNING** Refer to Speed and Feed charts for recommended adjustments to speeds and feeds. Refer to page A25: 60 for deep hole drilling guidelines in this section of the catalogue. Visit [www.alliedmachine.com/DeepHoleGuidelines](http://www.alliedmachine.com/DeepHoleGuidelines) for the most up-to-date information and procedures. Factory technical assistance is available for your specific applications through our Application Engineering department.  
email: [engineering.eu@alliedmachine.com](mailto:engineering.eu@alliedmachine.com)

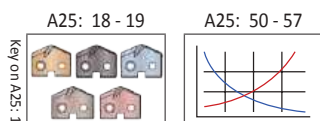

Ⓜ = Metric (mm)  
Ⓜ = Imperial (in)

Screws sold in multiples of 10.





T-A Pro Drill Holders

0 Series Metric | Diameter Range: 12.70 mm - 17.64 mm

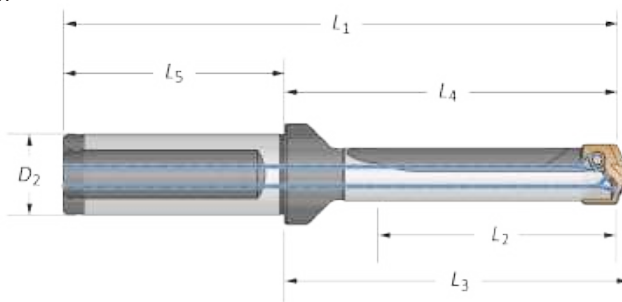

Length	Sub Series	Body				Shank				Flat	Part No.
		L <sub>2</sub>	L <sub>4</sub>	L <sub>3</sub>	L <sub>1</sub>	L <sub>5</sub>	D <sub>2</sub>				
10xD	A	153.2	185.0	187.8	235.1	50.0	20	Yes	HTA0A10-20FM		
10xD	A	153.2	185.0	187.8	235.1	50.0	20	No	HTA0A10-20CM		
10xD	B	153.2	185.0	187.8	235.1	50.0	20	Yes	HTA0B10-20FM		
10xD	B	153.2	185.0	187.8	235.1	50.0	20	No	HTA0B10-20CM		
10xD	C	153.2	185.0	187.8	235.1	50.0	20	Yes	HTA0C10-20FM		
10xD	C	153.2	185.0	187.8	235.1	50.0	20	No	HTA0C10-20CM		
10xD	D	153.2	185.0	187.8	235.1	50.0	20	Yes	HTA0D10-20FM		
10xD	D	153.2	185.0	187.8	235.1	50.0	20	No	HTA0D10-20CM		
12xD	A	183.8	215.7	218.4	265.7	50.0	20	Yes	HTA0A12-20FM		
12xD	A	183.8	215.7	218.4	265.7	50.0	20	No	HTA0A12-20CM		
12xD	B	183.8	215.7	218.4	265.7	50.0	20	Yes	HTA0B12-20FM		
12xD	B	183.8	215.7	218.4	265.7	50.0	20	No	HTA0B12-20CM		
12xD	C	183.8	215.7	218.4	265.7	50.0	20	Yes	HTA0C12-20FM		
12xD	C	183.8	215.7	218.4	265.7	50.0	20	No	HTA0C12-20CM		
12xD	D	183.8	215.7	218.4	265.7	50.0	20	Yes	HTA0D12-20FM		
12xD	D	183.8	215.7	218.4	265.7	50.0	20	No	HTA0D12-20CM		
15xD	A	229.7	261.6	264.3	311.6	50.0	20	Yes	HTA0A15-20FM		
15xD	A	229.7	261.6	264.3	311.6	50.0	20	No	HTA0A15-20CM		
15xD	B	229.7	261.6	264.3	311.6	50.0	20	Yes	HTA0B15-20FM		
15xD	B	229.7	261.6	264.3	311.6	50.0	20	No	HTA0B15-20CM		
15xD	C	229.7	261.6	264.3	311.6	50.0	20	Yes	HTA0C15-20FM		
15xD	C	229.7	261.6	264.3	311.6	50.0	20	No	HTA0C15-20CM		
15xD	D	229.7	261.6	264.3	311.6	50.0	20	Yes	HTA0D15-20FM		
15xD	D	229.7	261.6	264.3	311.6	50.0	20	No	HTA0D15-20CM		

Ⓜ

A

DRILLING

B

BORING

C

REAMING

D

BURNISHING

F

THREADING

X

SPECIALS

Connection Accessories

Sub Series	0 Series Holder Diameter Range	
	Metric (mm)	Imperial (inch)
0A	12.70 mm - 17.64 mm	0.4999" - 0.6946"
0B	14.00 mm - 17.64 mm	0.5510" - 0.6946"
0C	15.08 mm - 17.64 mm	0.5936" - 0.6946"
0D	16.50 mm - 17.64 mm	0.6495" - 0.6946"

	Insert Screws	Nylon Locking Screws	Insert Driver	Preset Torque Hand Driver	Replacement Tips	Admissible Tightening Torque*
A/B	72556-IP8-1	72556N-IP8-1	8IP-8	8IP-8TL	8IP-8B	175 N-cm (15.5 in-lbs)
C/D	72567-IP8-1	72567N-IP8-1	8IP-8	8IP-8TL	8IP-8B	175 N-cm (15.5 in-lbs)

\*Tightening torques are calculated with a friction coefficient of  $\mu = 0.14$  and develop 90% of ultimate yield strength.

**⚠ WARNING** Refer to Speed and Feed charts for recommended adjustments to speeds and feeds. Refer to page A25: 60 for deep hole drilling guidelines in this section of the catalogue. Visit [www.alliedmachine.com/DeepHoleGuidelines](http://www.alliedmachine.com/DeepHoleGuidelines) for the most up-to-date information and procedures. Factory technical assistance is available for your specific applications through our Application Engineering department.  
email: [engineering.eu@alliedmachine.com](mailto:engineering.eu@alliedmachine.com)

A25: 18 - 19      A25: 50 - 57

Ⓜ = Metric (mm)  
 ⓘ = Imperial (in)  
 Screws sold in multiples of 10.

T-A Pro Drill Holders

0 Series Imperial | Diameter Range: 0.4999" - 0.6946"

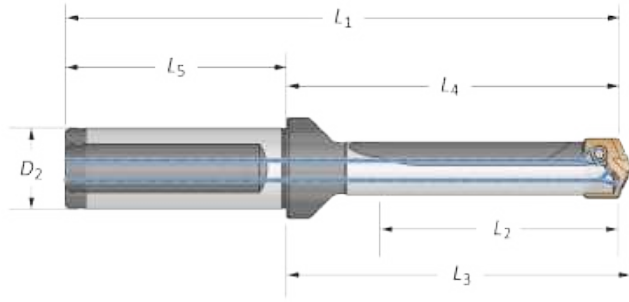

Body					Shank				Flat	Part No.
Length	Sub Series	L <sub>2</sub>	L <sub>4</sub>	L <sub>3</sub>	L <sub>1</sub>	L <sub>5</sub>	D <sub>2</sub>			
Stub	A	0.603	1.731	1.838	3.761	2.030	3/4	Yes	HTA0A01-075F	
Stub	A	0.603	1.731	1.838	3.761	2.030	3/4	No	HTA0A01-075C	
Stub	B	0.603	1.731	1.838	3.761	2.030	3/4	Yes	HTA0B01-075F	
Stub	B	0.603	1.731	1.838	3.761	2.030	3/4	No	HTA0B01-075C	
Stub	C	0.603	1.731	1.838	3.761	2.030	3/4	Yes	HTA0C01-075F	
Stub	C	0.603	1.731	1.838	3.761	2.030	3/4	No	HTA0C01-075C	
Stub	D	0.603	1.731	1.838	3.761	2.030	3/4	Yes	HTA0D01-075F	
Stub	D	0.603	1.731	1.838	3.761	2.030	3/4	No	HTA0D01-075C	
3xD	A	1.809	3.064	3.171	5.094	2.030	3/4	Yes	HTA0A03-075F	
3xD	A	1.809	3.064	3.171	5.094	2.030	3/4	No	HTA0A03-075C	
3xD	B	1.809	3.064	3.171	5.094	2.030	3/4	Yes	HTA0B03-075F	
3xD	B	1.809	3.064	3.171	5.094	2.030	3/4	No	HTA0B03-075C	
3xD	C	1.809	3.064	3.171	5.094	2.030	3/4	Yes	HTA0C03-075F	
3xD	C	1.809	3.064	3.171	5.094	2.030	3/4	No	HTA0C03-075C	
3xD	D	1.809	3.064	3.171	5.094	2.030	3/4	Yes	HTA0D03-075F	
3xD	D	1.809	3.064	3.171	5.094	2.030	3/4	No	HTA0D03-075C	
5xD	A	3.015	4.270	4.377	6.300	2.030	3/4	Yes	HTA0A05-075F	
5xD	A	3.015	4.270	4.377	6.300	2.030	3/4	No	HTA0A05-075C	
5xD	B	3.015	4.270	4.377	6.300	2.030	3/4	Yes	HTA0B05-075F	
5xD	B	3.015	4.270	4.377	6.300	2.030	3/4	No	HTA0B05-075C	
5xD	C	3.015	4.270	4.377	6.300	2.030	3/4	Yes	HTA0C05-075F	
5xD	C	3.015	4.270	4.377	6.300	2.030	3/4	No	HTA0C05-075C	
5xD	D	3.015	4.270	4.377	6.300	2.030	3/4	Yes	HTA0D05-075F	
5xD	D	3.015	4.270	4.377	6.300	2.030	3/4	No	HTA0D05-075C	
7xD	A	4.221	5.476	5.583	7.506	2.030	3/4	Yes	HTA0A07-075F	
7xD	A	4.221	5.476	5.583	7.506	2.030	3/4	No	HTA0A07-075C	
7xD	B	4.221	5.476	5.583	7.506	2.030	3/4	Yes	HTA0B07-075F	
7xD	B	4.221	5.476	5.583	7.506	2.030	3/4	No	HTA0B07-075C	
7xD	C	4.221	5.476	5.583	7.506	2.030	3/4	Yes	HTA0C07-075F	
7xD	C	4.221	5.476	5.583	7.506	2.030	3/4	No	HTA0C07-075C	
7xD	D	4.221	5.476	5.583	7.506	2.030	3/4	Yes	HTA0D07-075F	
7xD	D	4.221	5.476	5.583	7.506	2.030	3/4	No	HTA0D07-075C	

Connection Accessories

Sub Series	0 Series Holder Diameter Range	
	Metric (mm)	Imperial (inch)
0A	12.70 mm - 17.64 mm	0.4999" - 0.6946"
0B	14.00 mm - 17.64 mm	0.5510" - 0.6946"
0C	15.08 mm - 17.64 mm	0.5936" - 0.6946"
0D	16.50 mm - 17.64 mm	0.6495" - 0.6946"

	Insert Screws	Nylon Locking Screws	Insert Driver	Preset Torque Hand Driver	Replacement Tips	Admissible Tightening Torque*
A/B	72556-IP8-1	72556N-IP8-1	8IP-8	8IP-8TL	8IP-8B	175 N-cm (15.5 in-lbs)
C/D	72567-IP8-1	72567N-IP8-1	8IP-8	8IP-8TL	8IP-8B	175 N-cm (15.5 in-lbs)

\*Tightening torques are calculated with a friction coefficient of  $\mu = 0.14$  and develop 90% of ultimate yield strength.

**1. WARNING** Refer to Speed and Feed charts for recommended adjustments to speeds and feeds. Refer to page A25: 60 for deep hole drilling guidelines in this section of the catalogue. Visit [www.alliedmachine.com/DeepHoleGuidelines](http://www.alliedmachine.com/DeepHoleGuidelines) for the most up-to-date information and procedures. Factory technical assistance is available for your specific applications through our Application Engineering department.  
email: [engineering.eu@alliedmachine.com](mailto:engineering.eu@alliedmachine.com)

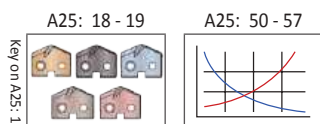

Ⓜ = Metric (mm)  
Ⓜ = Imperial (in)

Screws sold in multiples of 10.



T-A Pro Drill Holders

0 Series Imperial | Diameter Range: 0.4999" - 0.6946"

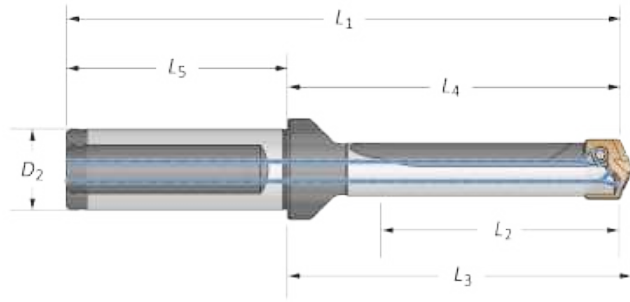

Body						Shank				Part No.
Length	Sub Series	L <sub>2</sub>	L <sub>4</sub>	L <sub>3</sub>	L <sub>1</sub>	L <sub>5</sub>	D <sub>2</sub>	Flat		
10xD	A	6.030	7.285	7.392	9.315	2.030	3/4	Yes	⚠ HTA0A10-075F	
10xD	A	6.030	7.285	7.392	9.315	2.030	3/4	No	⚠ HTA0A10-075C	
10xD	B	6.030	7.285	7.392	9.315	2.030	3/4	Yes	⚠ HTA0B10-075F	
10xD	B	6.030	7.285	7.392	9.315	2.030	3/4	No	⚠ HTA0B10-075C	
10xD	C	6.030	7.285	7.392	9.315	2.030	3/4	Yes	⚠ HTA0C10-075F	
10xD	C	6.030	7.285	7.392	9.315	2.030	3/4	No	⚠ HTA0C10-075C	
10xD	D	6.030	7.285	7.392	9.315	2.030	3/4	Yes	⚠ HTA0D10-075F	
10xD	D	6.030	7.285	7.392	9.315	2.030	3/4	No	⚠ HTA0D10-075C	
12xD	A	7.236	8.491	8.598	10.521	2.030	3/4	Yes	⚠ HTA0A12-075F	
12xD	A	7.236	8.491	8.598	10.521	2.030	3/4	No	⚠ HTA0A12-075C	
12xD	B	7.236	8.491	8.598	10.521	2.030	3/4	Yes	⚠ HTA0B12-075F	
12xD	B	7.236	8.491	8.598	10.521	2.030	3/4	No	⚠ HTA0B12-075C	
12xD	C	7.236	8.491	8.598	10.521	2.030	3/4	Yes	⚠ HTA0C12-075F	
12xD	C	7.236	8.491	8.598	10.521	2.030	3/4	No	⚠ HTA0C12-075C	
12xD	D	7.236	8.491	8.598	10.521	2.030	3/4	Yes	⚠ HTA0D12-075F	
12xD	D	7.236	8.491	8.598	10.521	2.030	3/4	No	⚠ HTA0D12-075C	
15xD	A	9.045	10.300	10.407	12.330	2.030	3/4	Yes	⚠ HTA0A15-075F	
15xD	A	9.045	10.300	10.407	12.330	2.030	3/4	No	⚠ HTA0A15-075C	
15xD	B	9.045	10.300	10.407	12.330	2.030	3/4	Yes	⚠ HTA0B15-075F	
15xD	B	9.045	10.300	10.407	12.330	2.030	3/4	No	⚠ HTA0B15-075C	
15xD	C	9.045	10.300	10.407	12.330	2.030	3/4	Yes	⚠ HTA0C15-075F	
15xD	C	9.045	10.300	10.407	12.330	2.030	3/4	No	⚠ HTA0C15-075C	
15xD	D	9.045	10.300	10.407	12.330	2.030	3/4	Yes	⚠ HTA0D15-075F	
15xD	D	9.045	10.300	10.407	12.330	2.030	3/4	No	⚠ HTA0D15-075C	

i

A

DRILLING

B

BORING

C

REAMING

D

BURNISHING

F

THREADING

X

SPECIALS

Connection Accessories

Sub Series	0 Series Holder Diameter Range	
	Metric (mm)	Imperial (inch)
0A	12.70 mm - 17.64 mm	0.4999" - 0.6946"
0B	14.00 mm - 17.64 mm	0.5510" - 0.6946"
0C	15.08 mm - 17.64 mm	0.5936" - 0.6946"
0D	16.50 mm - 17.64 mm	0.6495" - 0.6946"

	Insert Screws	Nylon Locking Screws	Insert Driver	Preset Torque Hand Driver	Replacement Tips	Admissible Tightening Torque*
A/B	72556-IP8-1	72556N-IP8-1	8IP-8	8IP-8TL	8IP-8B	175 N-cm (15.5 in-lbs)
C/D	72567-IP8-1	72567N-IP8-1	8IP-8	8IP-8TL	8IP-8B	175 N-cm (15.5 in-lbs)

\*Tightening torques are calculated with a friction coefficient of  $\mu = 0.14$  and develop 90% of ultimate yield strength.

**⚠ WARNING** Refer to Speed and Feed charts for recommended adjustments to speeds and feeds. Refer to page A25: 60 for deep hole drilling guidelines in this section of the catalogue. Visit [www.alliedmachine.com/DeepHoleGuidelines](http://www.alliedmachine.com/DeepHoleGuidelines) for the most up-to-date information and procedures. Factory technical assistance is available for your specific applications through our Application Engineering department.  
email: [engineering.eu@alliedmachine.com](mailto:engineering.eu@alliedmachine.com)

A25: 18 - 19 A25: 50 - 57





Ⓜ = Metric (mm)  
Ⓢ = Imperial (in)

Screws sold in multiples of 10.

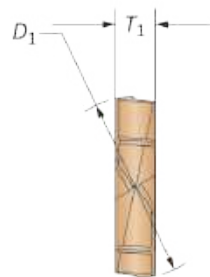
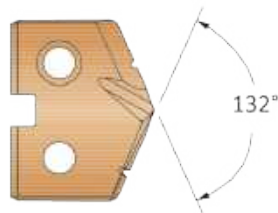
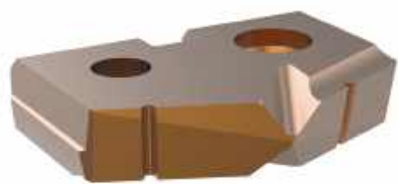
## T-A Pro Drill Inserts

1 Series | Diameter Range: 17.65 mm - 24.37 mm (0.6947" - 0.9596")



Insert					Carbide				HSS
Series	D <sub>1</sub> mm	D <sub>1</sub> inch	Fractional Equivalent	T <sub>1</sub>					
					Part No.	Part No.	Part No.	Part No.	Part No.
					P	K	N	M	X
1-A	17.70	0.6969	—	5/32	TAP1-17.70	TAK1-17.70	TAN1-17.70	TAM1-17.70	TAX1-17.70
1-A	17.80	0.7008	—	5/32	TAP1-17.80	TAK1-17.80	TAN1-17.80	TAM1-17.80	TAX1-17.80
1-A	17.86	0.7031	45/64	5/32	TAP1-17.86	TAK1-17.86	TAN1-17.86	TAM1-17.86	TAX1-17.86
1-A	17.90	0.7047	—	5/32	TAP1-17.90	TAK1-17.90	TAN1-17.90	TAM1-17.90	TAX1-17.90
1-A	18.00	0.7087	—	5/32	TAP1-18.00	TAK1-18.00	TAN1-18.00	TAM1-18.00	TAX1-18.00
1-A	18.10	0.7126	—	5/32	TAP1-18.10	TAK1-18.10	TAN1-18.10	TAM1-18.10	TAX1-18.10
1-A	18.20	0.7165	—	5/32	TAP1-18.20	TAK1-18.20	TAN1-18.20	TAM1-18.20	TAX1-18.20
1-A	18.26	0.7189	23/32	5/32	TAP1-18.26	TAK1-18.26	TAN1-18.26	TAM1-18.26	TAX1-18.26
1-A	18.30	0.7205	—	5/32	TAP1-18.30	TAK1-18.30	TAN1-18.30	TAM1-18.30	TAX1-18.30
1-A	18.40	0.7244	—	5/32	TAP1-18.40	TAK1-18.40	TAN1-18.40	TAM1-18.40	TAX1-18.40
1-A	18.50	0.7283	—	5/32	TAP1-18.50	TAK1-18.50	TAN1-18.50	TAM1-18.50	TAX1-18.50
1-A	18.60	0.7323	—	5/32	TAP1-18.60	TAK1-18.60	TAN1-18.60	TAM1-18.60	TAX1-18.60
1-A	18.65	0.7343	47/64	5/32	TAP1-18.65	TAK1-18.65	TAN1-18.65	TAM1-18.65	TAX1-18.65
1-A	18.70	0.7362	—	5/32	TAP1-18.70	TAK1-18.70	TAN1-18.70	TAM1-18.70	TAX1-18.70
1-A	18.80	0.7402	—	5/32	TAP1-18.80	TAK1-18.80	TAN1-18.80	TAM1-18.80	TAX1-18.80
1-A	18.90	0.7441	—	5/32	TAP1-18.90	TAK1-18.90	TAN1-18.90	TAM1-18.90	TAX1-18.90
1-A	19.00	0.7480	—	5/32	TAP1-19.00	TAK1-19.00	TAN1-19.00	TAM1-19.00	TAX1-19.00

Inserts sold in multiples of 2.

### Sub Series Holders (A, B, C, D)

Sub series holders are recommended when running carbide inserts toward the upper end of the series drill range, as well as in tougher applications requiring more insert support and holder strength. **NOTE:** Only specified sub series inserts should be used with equivalent or smaller sub series holders.



A Series Insert +  
A Series Holder



C Series Insert +  
A Series Holder



C Series Insert +  
C Series Holder



A Series Insert +  
C Series Holder

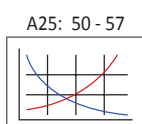
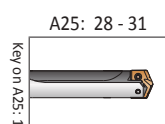

Key on A25: 1

Sizes not shown are available upon request.  
When ordering, please follow the example below:





<b>Metric:</b>	13.16 mm, steel, 0 series = use Part No. <b>TAP0-13.16</b>
<b>Imperial:</b>	0.5180", steel, 0 series = use Part No. <b>TAP0-13.16</b>

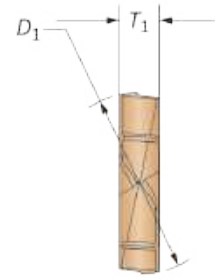
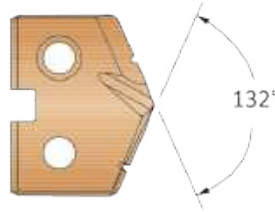

T-A Pro Drill Inserts

1 Series | Diameter Range: 17.65 mm - 24.37 mm (0.6947" - 0.9596")



Insert					Carbide				HSS
Series	D <sub>1</sub> mm	D <sub>1</sub> inch	Fractional Equivalent	T <sub>1</sub>					
					Part No.	Part No.	Part No.	Part No.	Part No.
					P	K	N	M	X
1-B	19.05	0.7500	3/4	5/32	TAP1-19.05	TAK1-19.05	TAN1-19.05	TAM1-19.05	TAX1-19.05
1-B	19.10	0.7520	—	5/32	TAP1-19.10	TAK1-19.10	TAN1-19.10	TAM1-19.10	TAX1-19.10
1-B	19.20	0.7559	—	5/32	TAP1-19.20	TAK1-19.20	TAN1-19.20	TAM1-19.20	TAX1-19.20
1-B	19.25	0.7579	—	5/32	TAP1-19.25	TAK1-19.25	TAN1-19.25	TAM1-19.25	TAX1-19.25
1-B	19.30	0.7598	—	5/32	TAP1-19.30	TAK1-19.30	TAN1-19.30	TAM1-19.30	TAX1-19.30
1-B	19.40	0.7638	—	5/32	TAP1-19.40	TAK1-19.40	TAN1-19.40	TAM1-19.40	TAX1-19.40
1-B	19.45	0.7657	49/64	5/32	TAP1-19.45	TAK1-19.45	TAN1-19.45	TAM1-19.45	TAX1-19.45
1-B	19.50	0.7677	—	5/32	TAP1-19.50	TAK1-19.50	TAN1-19.50	TAM1-19.50	TAX1-19.50
1-B	19.60	0.7717	—	5/32	TAP1-19.60	TAK1-19.60	TAN1-19.60	TAM1-19.60	TAX1-19.60
1-B	19.70	0.7756	—	5/32	TAP1-19.70	TAK1-19.70	TAN1-19.70	TAM1-19.70	TAX1-19.70
1-B	19.80	0.7795	—	5/32	TAP1-19.80	TAK1-19.80	TAN1-19.80	TAM1-19.80	TAX1-19.80
1-B	19.84	0.7811	25/32	5/32	TAP1-19.84	TAK1-19.84	TAN1-19.84	TAM1-19.84	TAX1-19.84
1-B	19.90	0.7835	—	5/32	TAP1-19.90	TAK1-19.90	TAN1-19.90	TAM1-19.90	TAX1-19.90
1-B	20.00	0.7874	—	5/32	TAP1-20.00	TAK1-20.00	TAN1-20.00	TAM1-20.00	TAX1-20.00
1-B	20.10	0.7913	—	5/32	TAP1-20.10	TAK1-20.10	TAN1-20.10	TAM1-20.10	TAX1-20.10
1-B	20.20	0.7953	—	5/32	TAP1-20.20	TAK1-20.20	TAN1-20.20	TAM1-20.20	TAX1-20.20
1-B	20.24	0.7969	51/64	5/32	TAP1-20.24	TAK1-20.24	TAN1-20.24	TAM1-20.24	TAX1-20.24
1-B	20.30	0.7992	—	5/32	TAP1-20.30	TAK1-20.30	TAN1-20.30	TAM1-20.30	TAX1-20.30
1-B	20.40	0.8031	—	5/32	TAP1-20.40	TAK1-20.40	TAN1-20.40	TAM1-20.40	TAX1-20.40
1-B	20.50	0.8071	—	5/32	TAP1-20.50	TAK1-20.50	TAN1-20.50	TAM1-20.50	TAX1-20.50

Inserts sold in multiples of 2.

Sub Series Holders (A, B, C, D)

Sub series holders are recommended when running carbide inserts toward the upper end of the series drill range, as well as in tougher applications requiring more insert support and holder strength. **NOTE:** Only specified sub series inserts should be used with equivalent or smaller sub series holders.



A Series Insert + A Series Holder



C Series Insert + A Series Holder



C Series Insert + C Series Holder



A Series Insert + C Series Holder

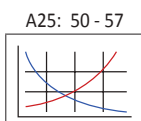
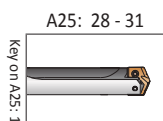



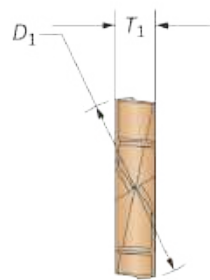
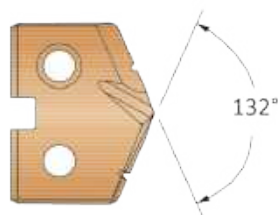

Sizes not shown are available upon request.	
When ordering, please follow the example below:	
<b>Metric:</b>	13.16 mm, steel, 0 series = use Part No. <b>TAP0-13.16</b>
<b>Imperial:</b>	0.5180", steel, 0 series = use Part No. <b>TAP0-13.16</b>

## T-A Pro Drill Inserts

1 Series | Diameter Range: 17.65 mm - 24.37 mm (0.6947" - 0.9596")



Insert					Carbide				HSS
Series	D <sub>1</sub> mm	D <sub>1</sub> inch	Fractional Equivalent	T <sub>1</sub>					
					Part No.	Part No.	Part No.	Part No.	Part No.
1-C	20.60	0.8110	—	5/32	P	K	N	M	X
1-C	20.64	0.8126	13/16	5/32	TAP1-20.60	TAK1-20.60	TAN1-20.60	TAM1-20.60	TAX1-20.60
1-C	20.64	0.8126	13/16	5/32	TAP1-20.64	TAK1-20.64	TAN1-20.64	TAM1-20.64	TAX1-20.64
1-C	20.70	0.8150	—	5/32	TAP1-20.70	TAK1-20.70	TAN1-20.70	TAM1-20.70	TAX1-20.70
1-C	20.80	0.8189	—	5/32	TAP1-20.80	TAK1-20.80	TAN1-20.80	TAM1-20.80	TAX1-20.80
1-C	20.90	0.8228	—	5/32	TAP1-20.90	TAK1-20.90	TAN1-20.90	TAM1-20.90	TAX1-20.90
1-C	21.00	0.8268	—	5/32	TAP1-21.00	TAK1-21.00	TAN1-21.00	TAM1-21.00	TAX1-21.00
1-C	21.10	0.8307	—	5/32	TAP1-21.10	TAK1-21.10	TAN1-21.10	TAM1-21.10	TAX1-21.10
1-C	21.20	0.8346	—	5/32	TAP1-21.20	TAK1-21.20	TAN1-21.20	TAM1-21.20	TAX1-21.20
1-C	21.30	0.8386	—	5/32	TAP1-21.30	TAK1-21.30	TAN1-21.30	TAM1-21.30	TAX1-21.30
1-C	21.40	0.8425	—	5/32	TAP1-21.40	TAK1-21.40	TAN1-21.40	TAM1-21.40	TAX1-21.40
1-C	21.43	0.8437	27/32	5/32	TAP1-21.43	TAK1-21.43	TAN1-21.43	TAM1-21.43	TAX1-21.43
1-C	21.50	0.8465	—	5/32	TAP1-21.50	TAK1-21.50	TAN1-21.50	TAM1-21.50	TAX1-21.50
1-C	21.60	0.8504	—	5/32	TAP1-21.60	TAK1-21.60	TAN1-21.60	TAM1-21.60	TAX1-21.60
1-C	21.70	0.8543	—	5/32	TAP1-21.70	TAK1-21.70	TAN1-21.70	TAM1-21.70	TAX1-21.70
1-C	21.80	0.8583	—	5/32	TAP1-21.80	TAK1-21.80	TAN1-21.80	TAM1-21.80	TAX1-21.80
1-C	21.83	0.8594	55/64	5/32	TAP1-21.83	TAK1-21.83	TAN1-21.83	TAM1-21.83	TAX1-21.83
1-C	21.90	0.8622	—	5/32	TAP1-21.90	TAK1-21.90	TAN1-21.90	TAM1-21.90	TAX1-21.90
1-C	22.00	0.8661	—	5/32	TAP1-22.00	TAK1-22.00	TAN1-22.00	TAM1-22.00	TAX1-22.00
1-C	22.10	0.8701	—	5/32	TAP1-22.10	TAK1-22.10	TAN1-22.10	TAM1-22.10	TAX1-22.10
1-C	22.20	0.8740	—	5/32	TAP1-22.20	TAK1-22.20	TAN1-22.20	TAM1-22.20	TAX1-22.20
1-C	22.23	0.8752	7/8	5/32	TAP1-22.23	TAK1-22.23	TAN1-22.23	TAM1-22.23	TAX1-22.23
1-C	22.30	0.8780	—	5/32	TAP1-22.30	TAK1-22.30	TAN1-22.30	TAM1-22.30	TAX1-22.30
1-C	22.40	0.8819	—	5/32	TAP1-22.40	TAK1-22.40	TAN1-22.40	TAM1-22.40	TAX1-22.40
1-C	22.50	0.8858	—	5/32	TAP1-22.50	TAK1-22.50	TAN1-22.50	TAM1-22.50	TAX1-22.50
1-C	22.62	0.8906	57/64	5/32	TAP1-22.62	TAK1-22.62	TAN1-22.62	TAM1-22.62	TAX1-22.62
1-C	22.70	0.8937	—	5/32	TAP1-22.70	TAK1-22.70	TAN1-22.70	TAM1-22.70	TAX1-22.70
1-C	22.80	0.8976	—	5/32	TAP1-22.80	TAK1-22.80	TAN1-22.80	TAM1-22.80	TAX1-22.80

Inserts sold in multiples of 2.

### Sub Series Holders (A, B, C, D)

Sub series holders are recommended when running carbide inserts toward the upper end of the series drill range, as well as in tougher applications requiring more insert support and holder strength. **NOTE:** Only specified sub series inserts should be used with equivalent or smaller sub series holders.



A Series Insert +  
A Series Holder



C Series Insert +  
A Series Holder



C Series Insert +  
C Series Holder



A Series Insert +  
C Series Holder

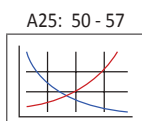
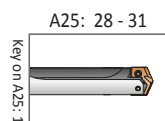

Key on A25: 1

Sizes not shown are available upon request.

When ordering, please follow the example below:





<b>Metric:</b>	13.16 mm, steel, 0 series = use Part No. <b>TAP0-13.16</b>
<b>Imperial:</b>	0.5180", steel, 0 series = use Part No. <b>TAP0-13.16</b>

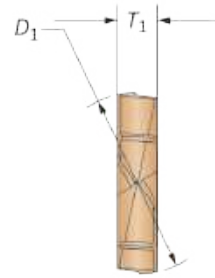
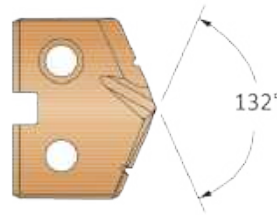

T-A Pro Drill Inserts

1 Series | Diameter Range: 17.65 mm - 24.37 mm (0.6947" - 0.9596")



Insert					Carbide				HSS
Series	D <sub>1</sub> mm	D <sub>1</sub> inch	Fractional Equivalent	T <sub>1</sub>					
					Part No.	Part No.	Part No.	Part No.	Part No.
					P	K	N	M	X
1-D	22.90	0.9016	—	5/32	TAP1-22.90	TAK1-22.90	TAN1-22.90	TAM1-22.90	TAX1-22.90
1-D	23.00	0.9055	—	5/32	TAP1-23.00	TAK1-23.00	TAN1-23.00	TAM1-23.00	TAX1-23.00
1-D	23.02	0.9063	29/32	5/32	TAP1-23.02	TAK1-23.02	TAN1-23.02	TAM1-23.02	TAX1-23.02
1-D	23.10	0.9094	—	5/32	TAP1-23.10	TAK1-23.10	TAN1-23.10	TAM1-23.10	TAX1-23.10
1-D	23.20	0.9134	—	5/32	TAP1-23.20	TAK1-23.20	TAN1-23.20	TAM1-23.20	TAX1-23.20
1-D	23.30	0.9173	—	5/32	TAP1-23.30	TAK1-23.30	TAN1-23.30	TAM1-23.30	TAX1-23.30
1-D	23.42	0.9220	59/64	5/32	TAP1-23.42	TAK1-23.42	TAN1-23.42	TAM1-23.42	TAX1-23.42
1-D	23.50	0.9252	—	5/32	TAP1-23.50	TAK1-23.50	TAN1-23.50	TAM1-23.50	TAX1-23.50
1-D	23.60	0.9291	—	5/32	TAP1-23.60	TAK1-23.60	TAN1-23.60	TAM1-23.60	TAX1-23.60
1-D	23.70	0.9331	—	5/32	TAP1-23.70	TAK1-23.70	TAN1-23.70	TAM1-23.70	TAX1-23.70
1-D	23.81	0.9374	15/16	5/32	TAP1-23.81	TAK1-23.81	TAN1-23.81	TAM1-23.81	TAX1-23.81
1-D	23.90	0.9409	—	5/32	TAP1-23.90	TAK1-23.90	TAN1-23.90	TAM1-23.90	TAX1-23.90
1-D	24.00	0.9449	—	5/32	TAP1-24.00	TAK1-24.00	TAN1-24.00	TAM1-24.00	TAX1-24.00
1-D	24.10	0.9488	—	5/32	TAP1-24.10	TAK1-24.10	TAN1-24.10	TAM1-24.10	TAX1-24.10
1-D	24.20	0.9528	—	5/32	TAP1-24.20	TAK1-24.20	TAN1-24.20	TAM1-24.20	TAX1-24.20
1-D	24.30	0.9567	—	5/32	TAP1-24.30	TAK1-24.30	TAN1-24.30	TAM1-24.30	TAX1-24.30

Inserts sold in multiples of 2.

Sub Series Holders (A, B, C, D)

Sub series holders are recommended when running carbide inserts toward the upper end of the series drill range, as well as in tougher applications requiring more insert support and holder strength. **NOTE:** Only specified sub series inserts should be used with equivalent or smaller sub series holders.



A Series Insert +  
A Series Holder



C Series Insert +  
A Series Holder



C Series Insert +  
C Series Holder



A Series Insert +  
C Series Holder

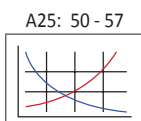
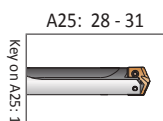

Sizes not shown are available upon request.	
When ordering, please follow the example below:	
<b>Metric:</b>	13.16 mm, steel, 0 series = use Part No. <b>TAP0-13.16</b>
<b>Imperial:</b>	0.5180", steel, 0 series = use Part No. <b>TAP0-13.16</b>

A DRILLING  
B BORING  
C REAMING  
D BURNISHING  
E THREADING  
X SPECIALS

## T-A Pro Drill Holders



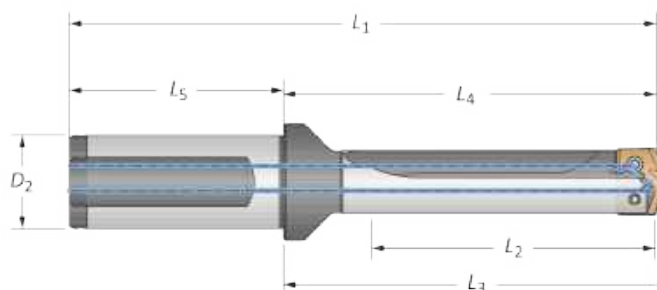

1 Series Metric | Diameter Range: 17.65 mm - 24.37 mm



		Body				Shank				
Length	Sub Series	L <sub>2</sub>	L <sub>4</sub>	L <sub>3</sub>	L <sub>1</sub>	L <sub>5</sub>	D <sub>2</sub>	Flat	Part No.	
Stub	A	21.0	56.5	60.0	112.5	56.0	25	Yes	HTA1A01-25FM	
Stub	A	21.0	56.5	60.0	112.5	56.0	25	No	HTA1A01-25CM	
Stub	B	21.0	56.5	60.0	112.5	56.0	25	Yes	HTA1B01-25FM	
Stub	B	21.0	56.5	60.0	112.5	56.0	25	No	HTA1B01-25CM	
Stub	C	21.0	56.5	60.0	112.5	56.0	25	Yes	HTA1C01-25FM	
Stub	C	21.0	56.5	60.0	112.5	56.0	25	No	HTA1C01-25CM	
Stub	D	21.0	56.5	60.0	112.5	56.0	25	Yes	HTA1D01-25FM	
Stub	D	21.0	56.5	60.0	112.5	56.0	25	No	HTA1D01-25CM	
3xD	A	62.9	100.9	104.5	156.9	56.0	25	Yes	HTA1A03-25FM	
3xD	A	62.9	100.9	104.5	156.9	56.0	25	No	HTA1A03-25CM	
3xD	B	62.9	100.9	104.5	156.9	56.0	25	Yes	HTA1B03-25FM	
3xD	B	62.9	100.9	104.5	156.9	56.0	25	No	HTA1B03-25CM	
3xD	C	62.9	100.9	104.5	156.9	56.0	25	Yes	HTA1C03-25FM	
3xD	C	62.9	100.9	104.5	156.9	56.0	25	No	HTA1C03-25CM	
3xD	D	62.9	100.9	104.5	156.9	56.0	25	Yes	HTA1D03-25FM	
3xD	D	62.9	100.9	104.5	156.9	56.0	25	No	HTA1D03-25CM	
5xD	A	104.8	142.8	146.4	198.8	56.0	25	Yes	HTA1A05-25FM	
5xD	A	104.8	142.8	146.4	198.8	56.0	25	No	HTA1A05-25CM	
5xD	B	104.8	142.8	146.4	198.8	56.0	25	Yes	HTA1B05-25FM	
5xD	B	104.8	142.8	146.4	198.8	56.0	25	No	HTA1B05-25CM	
5xD	C	104.8	142.8	146.4	198.8	56.0	25	Yes	HTA1C05-25FM	
5xD	C	104.8	142.8	146.4	198.8	56.0	25	No	HTA1C05-25CM	
5xD	D	104.8	142.8	146.4	198.8	56.0	25	Yes	HTA1D05-25FM	
5xD	D	104.8	142.8	146.4	198.8	56.0	25	No	HTA1D05-25CM	
7xD	A	146.7	184.7	188.3	240.7	56.0	25	Yes	HTA1A07-25FM	
7xD	A	146.7	184.7	188.3	240.7	56.0	25	No	HTA1A07-25CM	
7xD	B	146.7	184.7	188.3	240.7	56.0	25	Yes	HTA1B07-25FM	
7xD	B	146.7	184.7	188.3	240.7	56.0	25	No	HTA1B07-25CM	
7xD	C	146.7	184.7	188.3	240.7	56.0	25	Yes	HTA1C07-25FM	
7xD	C	146.7	184.7	188.3	240.7	56.0	25	No	HTA1C07-25CM	
7xD	D	146.7	184.7	188.3	240.7	56.0	25	Yes	HTA1D07-25FM	
7xD	D	146.7	184.7	188.3	240.7	56.0	25	No	HTA1D07-25CM	

### Connection Accessories

Sub Series	1 Series Holder Diameter Range	
	Metric (mm)	Imperial (inch)
1A	17.65 mm - 24.37 mm	0.6947" - 0.9596"
1B	19.05 mm - 24.37 mm	0.7499" - 0.9596"
1C	20.60 mm - 24.37 mm	0.8109" - 0.9596"
1D	22.90 mm - 24.37 mm	0.9014" - 0.9596"

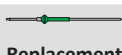
	 Insert Screws	 Nylon Locking Screws	 Insert Driver	 Preset Torque Hand Driver	 Replacement Tips	Admissible Tightening Torque*
A/B	7375-IP9-1	7375N-IP9-1	8IP-9	8IP-9TL	8IP-9B	305 N-cm (27.0 in-lbs)
C/D	739-IP9-1	739N-IP9-1	8IP-9	8IP-9TL	8IP-9B	305 N-cm (27.0 in-lbs)

\*Tightening torques are calculated with a friction coefficient of  $\mu = 0.14$  and develop 90% of ultimate yield strength.

**1. WARNING** Refer to Speed and Feed charts for recommended adjustments to speeds and feeds. Refer to page **A25: 60** for deep hole drilling guidelines in this section of the catalogue. Visit [www.alliedmachine.com/DeepHoleGuidelines](http://www.alliedmachine.com/DeepHoleGuidelines) for the most up-to-date information and procedures. Factory technical assistance is available for your specific applications through our Application Engineering department.  
email: [engineering.eu@alliedmachine.com](mailto:engineering.eu@alliedmachine.com)

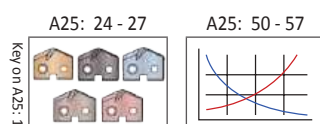

 = Metric (mm)  
 = Imperial (in)

Screws sold in multiples of 10.



**T-A Pro Drill Holders**

1 Series Metric | Diameter Range: 17.65 mm - 24.37 mm

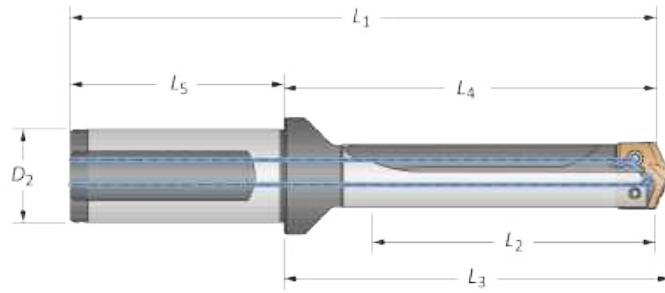

Length	Sub Series	Body				Shank			Flat	Part No.
		L <sub>2</sub>	L <sub>4</sub>	L <sub>3</sub>	L <sub>1</sub>	L <sub>5</sub>	D <sub>2</sub>			
10xD	A	209.6	247.6	251.2	303.6	56.0	25	Yes	HTA1A10-25FM	
10xD	A	209.6	247.6	251.2	303.6	56.0	25	No	HTA1A10-25CM	
10xD	B	209.6	247.6	251.2	303.6	56.0	25	Yes	HTA1B10-25FM	
10xD	B	209.6	247.6	251.2	303.6	56.0	25	No	HTA1B10-25CM	
10xD	C	209.6	247.6	251.2	303.6	56.0	25	Yes	HTA1C10-25FM	
10xD	C	209.6	247.6	251.2	303.6	56.0	25	No	HTA1C10-25CM	
10xD	D	209.6	247.6	251.2	303.6	56.0	25	Yes	HTA1D10-25FM	
10xD	D	209.6	247.6	251.2	303.6	56.0	25	No	HTA1D10-25CM	
12xD	A	251.5	289.5	293.1	345.5	56.0	25	Yes	HTA1A12-25FM	
12xD	A	251.5	289.5	293.1	345.5	56.0	25	No	HTA1A12-25CM	
12xD	B	251.5	289.5	293.1	345.5	56.0	25	Yes	HTA1B12-25FM	
12xD	B	251.5	289.5	293.1	345.5	56.0	25	No	HTA1B12-25CM	
12xD	C	251.5	289.5	293.1	345.5	56.0	25	Yes	HTA1C12-25FM	
12xD	C	251.5	289.5	293.1	345.5	56.0	25	No	HTA1C12-25CM	
12xD	D	251.5	289.5	293.1	345.5	56.0	25	Yes	HTA1D12-25FM	
12xD	D	251.5	289.5	293.1	345.5	56.0	25	No	HTA1D12-25CM	
15xD	A	314.3	352.4	355.9	408.4	56.0	25	Yes	HTA1A15-25FM	
15xD	A	314.3	352.4	355.9	408.4	56.0	25	No	HTA1A15-25CM	
15xD	B	314.3	352.4	355.9	408.4	56.0	25	Yes	HTA1B15-25FM	
15xD	B	314.3	352.4	355.9	408.4	56.0	25	No	HTA1B15-25CM	
15xD	C	314.3	352.4	355.9	408.4	56.0	25	Yes	HTA1C15-25FM	
15xD	C	314.3	352.4	355.9	408.4	56.0	25	No	HTA1C15-25CM	
15xD	D	314.3	352.4	355.9	408.4	56.0	25	Yes	HTA1D15-25FM	
15xD	D	314.3	352.4	355.9	408.4	56.0	25	No	HTA1D15-25CM	

Ⓜ

A

DRILLING

B

BORING

C

REAMING

D

BURNISHING

F





THREADING

X

SPECIALS

**Connection Accessories**

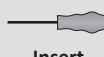
Sub Series	1 Series Holder Diameter Range	
	Metric (mm)	Imperial (inch)
1A	17.65 mm - 24.37 mm	0.6947" - 0.9596"
1B	19.05 mm - 24.37 mm	0.7499" - 0.9596"
1C	20.60 mm - 24.37 mm	0.8109" - 0.9596"
1D	22.90 mm - 24.37 mm	0.9014" - 0.9596"

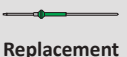
	 Insert Screws	 Nylon Locking Screws	 Insert Driver	 Preset Torque Hand Driver	 Replacement Tips	Admissible Tightening Torque*
A/B	7375-IP9-1	7375N-IP9-1	8IP-9	8IP-9TL	8IP-9B	305 N-cm (27.0 in-lbs)
C/D	739-IP9-1	739N-IP9-1	8IP-9	8IP-9TL	8IP-9B	305 N-cm (27.0 in-lbs)

\*Tightening torques are calculated with a friction coefficient of  $\mu = 0.14$  and develop 90% of ultimate yield strength.

**1 WARNING** Refer to Speed and Feed charts for recommended adjustments to speeds and feeds. Refer to page **A25: 60** for deep hole drilling guidelines in this section of the catalogue. Visit [www.alliedmachine.com/DeepHoleGuidelines](http://www.alliedmachine.com/DeepHoleGuidelines) for the most up-to-date information and procedures. Factory technical assistance is available for your specific applications through our Application Engineering department.  
email: [engineering.eu@alliedmachine.com](mailto:engineering.eu@alliedmachine.com)

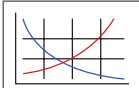
A25: 24 - 27  

Ⓜ = Metric (mm)  
Ⓜ = Imperial (in)  
Screws sold in multiples of 10.

## T-A Pro Drill Holders



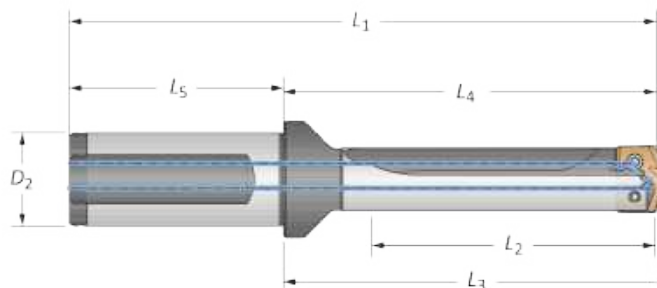

1 Series Imperial | Diameter Range: 0.6947" - 0.9596"



		Body				Shank				
Length	Sub Series	L <sub>2</sub>	L <sub>4</sub>	L <sub>3</sub>	L <sub>1</sub>	L <sub>5</sub>	D <sub>2</sub>	Flat	Part No.	
Stub	A	0.825	2.224	2.364	4.504	2.280	1	Yes	HTA1A01-100F	
Stub	A	0.825	2.224	2.364	4.504	2.280	1	No	HTA1A01-100C	
Stub	B	0.825	2.224	2.364	4.504	2.280	1	Yes	HTA1B01-100F	
Stub	B	0.825	2.224	2.364	4.504	2.280	1	No	HTA1B01-100C	
Stub	C	0.825	2.224	2.364	4.504	2.280	1	Yes	HTA1C01-100F	
Stub	C	0.825	2.224	2.364	4.504	2.280	1	No	HTA1C01-100C	
Stub	D	0.825	2.224	2.364	4.504	2.280	1	Yes	HTA1D01-100F	
Stub	D	0.825	2.224	2.364	4.504	2.280	1	No	HTA1D01-100C	
3xD	A	2.475	3.973	4.113	6.253	2.280	1	Yes	HTA1A03-100F	
3xD	A	2.475	3.973	4.113	6.253	2.280	1	No	HTA1A03-100C	
3xD	B	2.475	3.973	4.113	6.253	2.280	1	Yes	HTA1B03-100F	
3xD	B	2.475	3.973	4.113	6.253	2.280	1	No	HTA1B03-100C	
3xD	C	2.475	3.973	4.113	6.253	2.280	1	Yes	HTA1C03-100F	
3xD	C	2.475	3.973	4.113	6.253	2.280	1	No	HTA1C03-100C	
3xD	D	2.475	3.973	4.113	6.253	2.280	1	Yes	HTA1D03-100F	
3xD	D	2.475	3.973	4.113	6.253	2.280	1	No	HTA1D03-100C	
5xD	A	4.125	5.623	5.763	7.903	2.280	1	Yes	HTA1A05-100F	
5xD	A	4.125	5.623	5.763	7.903	2.280	1	No	HTA1A05-100C	
5xD	B	4.125	5.623	5.763	7.903	2.280	1	Yes	HTA1B05-100F	
5xD	B	4.125	5.623	5.763	7.903	2.280	1	No	HTA1B05-100C	
5xD	C	4.125	5.623	5.763	7.903	2.280	1	Yes	HTA1C05-100F	
5xD	C	4.125	5.623	5.763	7.903	2.280	1	No	HTA1C05-100C	
5xD	D	4.125	5.623	5.763	7.903	2.280	1	Yes	HTA1D05-100F	
5xD	D	4.125	5.623	5.763	7.903	2.280	1	No	HTA1D05-100C	
7xD	A	5.775	7.273	7.413	9.553	2.280	1	Yes	HTA1A07-100F	
7xD	A	5.775	7.273	7.413	9.553	2.280	1	No	HTA1A07-100C	
7xD	B	5.775	7.273	7.413	9.553	2.280	1	Yes	HTA1B07-100F	
7xD	B	5.775	7.273	7.413	9.553	2.280	1	No	HTA1B07-100C	
7xD	C	5.775	7.273	7.413	9.553	2.280	1	Yes	HTA1C07-100F	
7xD	C	5.775	7.273	7.413	9.553	2.280	1	No	HTA1C07-100C	
7xD	D	5.775	7.273	7.413	9.553	2.280	1	Yes	HTA1D07-100F	
7xD	D	5.775	7.273	7.413	9.553	2.280	1	No	HTA1D07-100C	

Sub Series	1 Series Holder Diameter Range	
	Metric (mm)	Imperial (inch)
1A	17.65 mm - 24.37 mm	0.6947" - 0.9596"
1B	19.05 mm - 24.37 mm	0.7499" - 0.9596"
1C	20.60 mm - 24.37 mm	0.8109" - 0.9596"
1D	22.90 mm - 24.37 mm	0.9014" - 0.9596"

### Connection Accessories

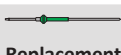
	 Insert Screws	 Nylon Locking Screws	 Insert Driver	 Preset Torque Hand Driver	 Replacement Tips	Admissible Tightening Torque*
A/B	7375-IP9-1	7375N-IP9-1	8IP-9	8IP-9TL	8IP-9B	305 N-cm (27.0 in-lbs)
C/D	739-IP9-1	739N-IP9-1	8IP-9	8IP-9TL	8IP-9B	305 N-cm (27.0 in-lbs)

\*Tightening torques are calculated with a friction coefficient of  $\mu = 0.14$  and develop 90% of ultimate yield strength.

**1. WARNING** Refer to Speed and Feed charts for recommended adjustments to speeds and feeds. Refer to page **A25: 60** for deep hole drilling guidelines in this section of the catalogue. Visit [www.alliedmachine.com/DeepHoleGuidelines](http://www.alliedmachine.com/DeepHoleGuidelines) for the most up-to-date information and procedures. Factory technical assistance is available for your specific applications through our Application Engineering department.  
email: [engineering.eu@alliedmachine.com](mailto:engineering.eu@alliedmachine.com)

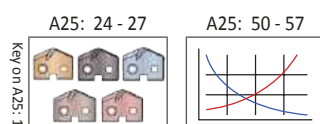

 = Metric (mm)  
 = Imperial (in)

Screws sold in multiples of 10.



T-A Pro Drill Holders

1 Series Imperial | Diameter Range: 0.6947" - 0.9596"

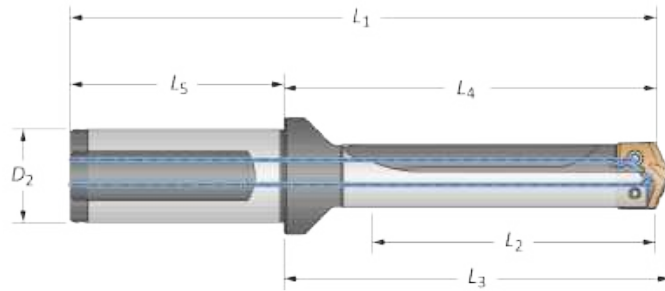

Length	Sub Series	Body				Shank			Flat	Part No.
		L <sub>2</sub>	L <sub>4</sub>	L <sub>3</sub>	L <sub>1</sub>	L <sub>5</sub>	D <sub>2</sub>			
10xD	A	8.250	9.748	9.888	12.028	2.280	1	Yes	HTA1A10-100F	
10xD	A	8.250	9.748	9.888	12.028	2.280	1	No	HTA1A10-100C	
10xD	B	8.250	9.748	9.888	12.028	2.280	1	Yes	HTA1B10-100F	
10xD	B	8.250	9.748	9.888	12.028	2.280	1	No	HTA1B10-100C	
10xD	C	8.250	9.748	9.888	12.028	2.280	1	Yes	HTA1C10-100F	
10xD	C	8.250	9.748	9.888	12.028	2.280	1	No	HTA1C10-100C	
10xD	D	8.250	9.748	9.888	12.028	2.280	1	Yes	HTA1D10-100F	
10xD	D	8.250	9.748	9.888	12.028	2.280	1	No	HTA1D10-100C	
12xD	A	9.900	11.398	11.538	13.678	2.280	1	Yes	HTA1A12-100F	
12xD	A	9.900	11.398	11.538	13.678	2.280	1	No	HTA1A12-100C	
12xD	B	9.900	11.398	11.538	13.678	2.280	1	Yes	HTA1B12-100F	
12xD	B	9.900	11.398	11.538	13.678	2.280	1	No	HTA1B12-100C	
12xD	C	9.900	11.398	11.538	13.678	2.280	1	Yes	HTA1C12-100F	
12xD	C	9.900	11.398	11.538	13.678	2.280	1	No	HTA1C12-100C	
12xD	D	9.900	11.398	11.538	13.678	2.280	1	Yes	HTA1D12-100F	
12xD	D	9.900	11.398	11.538	13.678	2.280	1	No	HTA1D12-100C	
15xD	A	12.375	13.873	14.013	16.153	2.280	1	Yes	HTA1A15-100F	
15xD	A	12.375	13.873	14.013	16.153	2.280	1	No	HTA1A15-100C	
15xD	B	12.375	13.873	14.013	16.153	2.280	1	Yes	HTA1B15-100F	
15xD	B	12.375	13.873	14.013	16.153	2.280	1	No	HTA1B15-100C	
15xD	C	12.375	13.873	14.013	16.153	2.280	1	Yes	HTA1C15-100F	
15xD	C	12.375	13.873	14.013	16.153	2.280	1	No	HTA1C15-100C	
15xD	D	12.375	13.873	14.013	16.153	2.280	1	Yes	HTA1D15-100F	
15xD	D	12.375	13.873	14.013	16.153	2.280	1	No	HTA1D15-100C	

1

A

DRILLING

B

BORING

C

REAMING

D

BURNISHING

F

THREADING

X

SPECIALS

Connection Accessories

Sub Series	1 Series Holder Diameter Range	
	Metric (mm)	Imperial (inch)
1A	17.65 mm - 24.37 mm	0.6947" - 0.9596"
1B	19.05 mm - 24.37 mm	0.7499" - 0.9596"
1C	20.60 mm - 24.37 mm	0.8109" - 0.9596"
1D	22.90 mm - 24.37 mm	0.9014" - 0.9596"

	Insert Screws	Nylon Locking Screws	Insert Driver	Preset Torque Hand Driver	Replacement Tips	Admissible Tightening Torque*
A/B	7375-IP9-1	7375N-IP9-1	8IP-9	8IP-9TL	8IP-9B	305 N-cm (27.0 in-lbs)
C/D	739-IP9-1	739N-IP9-1	8IP-9	8IP-9TL	8IP-9B	305 N-cm (27.0 in-lbs)

\*Tightening torques are calculated with a friction coefficient of  $\mu = 0.14$  and develop 90% of ultimate yield strength.

**1 WARNING** Refer to Speed and Feed charts for recommended adjustments to speeds and feeds. Refer to page A25: 60 for deep hole drilling guidelines in this section of the catalogue. Visit [www.alliedmachine.com/DeepHoleGuidelines](http://www.alliedmachine.com/DeepHoleGuidelines) for the most up-to-date information and procedures. Factory technical assistance is available for your specific applications through our Application Engineering department.  
email: [engineering.eu@alliedmachine.com](mailto:engineering.eu@alliedmachine.com)





A25: 24 - 27      A25: 50 - 57

Ⓜ = Metric (mm)  
Ⓢ = Imperial (in)  
Screws sold in multiples of 10.

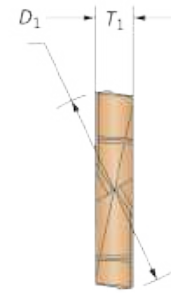
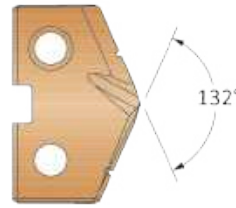
## T-A Pro Drill Inserts

2 Series | Diameter Range: 24.38 mm - 35.04 mm (0.9597" - 1.3797")



Insert					Carbide				HSS
Series	$D_1$ mm	$D_1$ inch	Fractional Equivalent	$T_1$					
					Part No.	Part No.	Part No.	Part No.	Part No.
2-A	24.40	0.9606	—	3/16	<b>TAP2-24.40</b>	<b>TAK2-24.40</b>	<b>TAN2-24.40</b>	<b>TAM2-24.40</b>	<b>TAX2-24.40</b>
2-A	24.50	0.9646	—	3/16	<b>TAP2-24.50</b>	<b>TAK2-24.50</b>	<b>TAN2-24.50</b>	<b>TAM2-24.50</b>	<b>TAX2-24.50</b>
2-A	24.61	0.9689	31/32	3/16	<b>TAP2-24.61</b>	<b>TAK2-24.61</b>	<b>TAN2-24.61</b>	<b>TAM2-24.61</b>	<b>TAX2-24.61</b>
2-A	24.70	0.9724	—	3/16	<b>TAP2-24.70</b>	<b>TAK2-24.70</b>	<b>TAN2-24.70</b>	<b>TAM2-24.70</b>	<b>TAX2-24.70</b>
2-A	24.80	0.9764	—	3/16	<b>TAP2-24.80</b>	<b>TAK2-24.80</b>	<b>TAN2-24.80</b>	<b>TAM2-24.80</b>	<b>TAX2-24.80</b>
2-A	24.90	0.9803	—	3/16	<b>TAP2-24.90</b>	<b>TAK2-24.90</b>	<b>TAN2-24.90</b>	<b>TAM2-24.90</b>	<b>TAX2-24.90</b>
2-A	25.00	0.9843	63/64	3/16	<b>TAP2-25.00</b>	<b>TAK2-25.00</b>	<b>TAN2-25.00</b>	<b>TAM2-25.00</b>	<b>TAX2-25.00</b>
2-A	25.10	0.9882	—	3/16	<b>TAP2-25.10</b>	<b>TAK2-25.10</b>	<b>TAN2-25.10</b>	<b>TAM2-25.10</b>	<b>TAX2-25.10</b>
2-A	25.20	0.9921	—	3/16	<b>TAP2-25.20</b>	<b>TAK2-25.20</b>	<b>TAN2-25.20</b>	<b>TAM2-25.20</b>	<b>TAX2-25.20</b>
2-A	25.30	0.9961	—	3/16	<b>TAP2-25.30</b>	<b>TAK2-25.30</b>	<b>TAN2-25.30</b>	<b>TAM2-25.30</b>	<b>TAX2-25.30</b>

Inserts sold in multiples of 2.

### Sub Series Holders (A, B, C, D)

Sub series holders are recommended when running carbide inserts toward the upper end of the series drill range, as well as in tougher applications requiring more insert support and holder strength. **NOTE:** Only specified sub series inserts should be used with equivalent or smaller sub series holders.



A Series Insert +  
A Series Holder



C Series Insert +  
A Series Holder



C Series Insert +  
C Series Holder



A Series Insert +  
C Series Holder

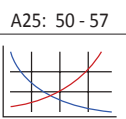
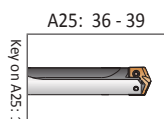

Key on A25: 1

Sizes not shown are available upon request.  
When ordering, please follow the example below:

<b>Metric:</b>	13.16 mm, steel, 0 series = use Part No. <b>TAP0-13.16</b>
<b>Imperial:</b>	0.5180", steel, 0 series = use Part No. <b>TAP0-13.16</b>

### T-A Pro Drill Inserts

2 Series | Diameter Range: 24.38 mm - 35.04 mm (0.9597" - 1.3797")

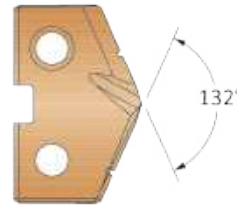

Insert					Carbide				HSS
Series	D <sub>1</sub> mm	D <sub>1</sub> inch	Fractional Equivalent	T <sub>1</sub>					
					Part No.	Part No.	Part No.	Part No.	Part No.
					P	K	N	M	X
2-B	25.40	1.0000	1	3/16	TAP2-25.40	TAK2-25.40	TAN2-25.40	TAM2-25.40	TAX2-25.40
2-B	25.50	1.0039	—	3/16	TAP2-25.50	TAK2-25.50	TAN2-25.50	TAM2-25.50	TAX2-25.50
2-B	25.60	1.0079	—	3/16	TAP2-25.60	TAK2-25.60	TAN2-25.60	TAM2-25.60	TAX2-25.60
2-B	25.70	1.0118	—	3/16	TAP2-25.70	TAK2-25.70	TAN2-25.70	TAM2-25.70	TAX2-25.70
2-B	25.78	1.0150	—	3/16	TAP2-25.78	TAK2-25.78	TAN2-25.78	TAM2-25.78	TAX2-25.78
2-B	25.90	1.0197	—	3/16	TAP2-25.90	TAK2-25.90	TAN2-25.90	TAM2-25.90	TAX2-25.90
2-B	26.00	1.0236	—	3/16	TAP2-26.00	TAK2-26.00	TAN2-26.00	TAM2-26.00	TAX2-26.00
2-B	26.10	1.0276	—	3/16	TAP2-26.10	TAK2-26.10	TAN2-26.10	TAM2-26.10	TAX2-26.10
2-B	26.20	1.0315	1-1/32	3/16	TAP2-26.20	TAK2-26.20	TAN2-26.20	TAM2-26.20	TAX2-26.20
2-B	26.30	1.0354	—	3/16	TAP2-26.30	TAK2-26.30	TAN2-26.30	TAM2-26.30	TAX2-26.30
2-B	26.40	1.0394	—	3/16	TAP2-26.40	TAK2-26.40	TAN2-26.40	TAM2-26.40	TAX2-26.40
2-B	26.50	1.0433	—	3/16	TAP2-26.50	TAK2-26.50	TAN2-26.50	TAM2-26.50	TAX2-26.50
2-B	26.57	1.0461	—	3/16	TAP2-26.57	TAK2-26.57	TAN2-26.57	TAM2-26.57	TAX2-26.57
2-B	26.59	1.0469	1-3/64	3/16	TAP2-26.59	TAK2-26.59	TAN2-26.59	TAM2-26.59	TAX2-26.59
2-B	26.60	1.0472	—	3/16	TAP2-26.60	TAK2-26.60	TAN2-26.60	TAM2-26.60	TAX2-26.60
2-B	26.70	1.0512	—	3/16	TAP2-26.70	TAK2-26.70	TAN2-26.70	TAM2-26.70	TAX2-26.70
2-B	26.80	1.0551	—	3/16	TAP2-26.80	TAK2-26.80	TAN2-26.80	TAM2-26.80	TAX2-26.80
2-B	26.90	1.0591	—	3/16	TAP2-26.90	TAK2-26.90	TAN2-26.90	TAM2-26.90	TAX2-26.90
2-B	26.99	1.0626	1-1/16	3/16	TAP2-26.99	TAK2-26.99	TAN2-26.99	TAM2-26.99	TAX2-26.99
2-B	27.00	1.0630	—	3/16	TAP2-27.00	TAK2-27.00	TAN2-27.00	TAM2-27.00	TAX2-27.00
2-B	27.10	1.0669	—	3/16	TAP2-27.10	TAK2-27.10	TAN2-27.10	TAM2-27.10	TAX2-27.10
2-B	27.20	1.0709	—	3/16	TAP2-27.20	TAK2-27.20	TAN2-27.20	TAM2-27.20	TAX2-27.20
2-B	27.30	1.0748	—	3/16	TAP2-27.30	TAK2-27.30	TAN2-27.30	TAM2-27.30	TAX2-27.30
2-B	27.40	1.0787	—	3/16	TAP2-27.40	TAK2-27.40	TAN2-27.40	TAM2-27.40	TAX2-27.40
2-B	27.50	1.0827	—	3/16	TAP2-27.50	TAK2-27.50	TAN2-27.50	TAM2-27.50	TAX2-27.50
2-B	27.60	1.0866	—	3/16	TAP2-27.60	TAK2-27.60	TAN2-27.60	TAM2-27.60	TAX2-27.60
2-B	27.70	1.0906	—	3/16	TAP2-27.70	TAK2-27.70	TAN2-27.70	TAM2-27.70	TAX2-27.70
2-B	27.78	1.0937	1-3/32	3/16	TAP2-27.78	TAK2-27.78	TAN2-27.78	TAM2-27.78	TAX2-27.78
2-B	27.90	1.0984	—	3/16	TAP2-27.90	TAK2-27.90	TAN2-27.90	TAM2-27.90	TAX2-27.90
2-B	28.00	1.1024	—	3/16	TAP2-28.00	TAK2-28.00	TAN2-28.00	TAM2-28.00	TAX2-28.00
2-B	28.10	1.1063	—	3/16	TAP2-28.10	TAK2-28.10	TAN2-28.10	TAM2-28.10	TAX2-28.10
2-B	28.17	1.1091	1-7/64	3/16	TAP2-28.17	TAK2-28.17	TAN2-28.17	TAM2-28.17	TAX2-28.17
2-B	28.20	1.1102	—	3/16	TAP2-28.20	TAK2-28.20	TAN2-28.20	TAM2-28.20	TAX2-28.20
2-B	28.30	1.1142	—	3/16	TAP2-28.30	TAK2-28.30	TAN2-28.30	TAM2-28.30	TAX2-28.30
2-B	28.40	1.1181	—	3/16	TAP2-28.40	TAK2-28.40	TAN2-28.40	TAM2-28.40	TAX2-28.40

Inserts sold in multiples of 2.

**Sub Series Holders (A, B, C, D)**  
 Sub series holders are recommended when running carbide inserts toward the upper end of the series drill range, as well as in tougher applications requiring more insert support and holder strength. **NOTE:** Only specified sub series inserts should be used with equivalent or smaller sub series holders.

A Series Insert +  
A Series Holder

C Series Insert +  
A Series Holder

C Series Insert +  
C Series Holder

A Series Insert +  
C Series Holder

A25: 36 - 39      A25: 50 - 57

Sizes not shown are available upon request.  
 When ordering, please follow the example below:





<b>Metric:</b>	13.16 mm, steel, 0 series = use Part No. <b>TAP0-13.16</b>
<b>Imperial:</b>	0.5180", steel, 0 series = use Part No. <b>TAP0-13.16</b>

A DRILLING  
B BORING  
C REAMING  
D BURNISHING  
E THREADING  
X SPECIALS

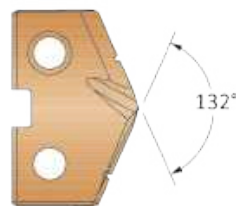
## T-A Pro Drill Inserts

2 Series | Diameter Range: 24.38 mm - 35.04 mm (0.9597" - 1.3797")



Insert					Carbide				HSS
Series	D <sub>1</sub> mm	D <sub>1</sub> inch	Fractional Equivalent	T <sub>1</sub>					
					Part No.	Part No.	Part No.	Part No.	Part No.
					P	K	N	M	X
2-C	28.50	1.1220	—	3/16	TAP2-28.50	TAK2-28.50	TAN2-28.50	TAM2-28.50	TAX2-28.50
2-C	28.58	1.1252	1-1/8	3/16	TAP2-28.58	TAK2-28.58	TAN2-28.58	TAM2-28.58	TAX2-28.58
2-C	28.70	1.1299	—	3/16	TAP2-28.70	TAK2-28.70	TAN2-28.70	TAM2-28.70	TAX2-28.70
2-C	28.80	1.1339	—	3/16	TAP2-28.80	TAK2-28.80	TAN2-28.80	TAM2-28.80	TAX2-28.80
2-C	28.90	1.1378	—	3/16	TAP2-28.90	TAK2-28.90	TAN2-28.90	TAM2-28.90	TAX2-28.90
2-C	29.00	1.1417	—	3/16	TAP2-29.00	TAK2-29.00	TAN2-29.00	TAM2-29.00	TAX2-29.00
2-C	29.10	1.1457	—	3/16	TAP2-29.10	TAK2-29.10	TAN2-29.10	TAM2-29.10	TAX2-29.10
2-C	29.20	1.1496	—	3/16	TAP2-29.20	TAK2-29.20	TAN2-29.20	TAM2-29.20	TAX2-29.20
2-C	29.30	1.1535	—	3/16	TAP2-29.30	TAK2-29.30	TAN2-29.30	TAM2-29.30	TAX2-29.30
2-C	29.37	1.1563	1-5/32	3/16	TAP2-29.37	TAK2-29.37	TAN2-29.37	TAM2-29.37	TAX2-29.37
2-C	29.40	1.1575	—	3/16	TAP2-29.40	TAK2-29.40	TAN2-29.40	TAM2-29.40	TAX2-29.40
2-C	29.50	1.1614	—	3/16	TAP2-29.50	TAK2-29.50	TAN2-29.50	TAM2-29.50	TAX2-29.50
2-C	29.60	1.1654	—	3/16	TAP2-29.60	TAK2-29.60	TAN2-29.60	TAM2-29.60	TAX2-29.60
2-C	29.70	1.1693	—	3/16	TAP2-29.70	TAK2-29.70	TAN2-29.70	TAM2-29.70	TAX2-29.70
2-C	29.80	1.1732	—	3/16	TAP2-29.80	TAK2-29.80	TAN2-29.80	TAM2-29.80	TAX2-29.80
2-C	29.90	1.1772	—	3/16	TAP2-29.90	TAK2-29.90	TAN2-29.90	TAM2-29.90	TAX2-29.90
2-C	30.00	1.1811	—	3/16	TAP2-30.00	TAK2-30.00	TAN2-30.00	TAM2-30.00	TAX2-30.00
2-C	30.10	1.1850	—	3/16	TAP2-30.10	TAK2-30.10	TAN2-30.10	TAM2-30.10	TAX2-30.10
2-C	30.16	1.1874	1-3/16	3/16	TAP2-30.16	TAK2-30.16	TAN2-30.16	TAM2-30.16	TAX2-30.16
2-C	30.20	1.1890	—	3/16	TAP2-30.20	TAK2-30.20	TAN2-30.20	TAM2-30.20	TAX2-30.20
2-C	30.30	1.1929	—	3/16	TAP2-30.30	TAK2-30.30	TAN2-30.30	TAM2-30.30	TAX2-30.30
2-C	30.40	1.1969	—	3/16	TAP2-30.40	TAK2-30.40	TAN2-30.40	TAM2-30.40	TAX2-30.40
2-C	30.50	1.2008	—	3/16	TAP2-30.50	TAK2-30.50	TAN2-30.50	TAM2-30.50	TAX2-30.50
2-C	30.60	1.2047	—	3/16	TAP2-30.60	TAK2-30.60	TAN2-30.60	TAM2-30.60	TAX2-30.60
2-C	30.70	1.2087	—	3/16	TAP2-30.70	TAK2-30.70	TAN2-30.70	TAM2-30.70	TAX2-30.70
2-C	30.80	1.2126	—	3/16	TAP2-30.80	TAK2-30.80	TAN2-30.80	TAM2-30.80	TAX2-30.80
2-C	30.90	1.2165	—	3/16	TAP2-30.90	TAK2-30.90	TAN2-30.90	TAM2-30.90	TAX2-30.90
2-C	30.96	1.2189	1-7/32	3/16	TAP2-30.96	TAK2-30.96	TAN2-30.96	TAM2-30.96	TAX2-30.96
2-C	31.00	1.2205	—	3/16	TAP2-31.00	TAK2-31.00	TAN2-31.00	TAM2-31.00	TAX2-31.00
2-C	31.10	1.2244	—	3/16	TAP2-31.10	TAK2-31.10	TAN2-31.10	TAM2-31.10	TAX2-31.10
2-C	31.20	1.2283	—	3/16	TAP2-31.20	TAK2-31.20	TAN2-31.20	TAM2-31.20	TAX2-31.20
2-C	31.30	1.2323	—	3/16	TAP2-31.30	TAK2-31.30	TAN2-31.30	TAM2-31.30	TAX2-31.30
2-C	31.40	1.2362	—	3/16	TAP2-31.40	TAK2-31.40	TAN2-31.40	TAM2-31.40	TAX2-31.40
2-C	31.50	1.2402	—	3/16	TAP2-31.50	TAK2-31.50	TAN2-31.50	TAM2-31.50	TAX2-31.50
2-C	31.60	1.2441	—	3/16	TAP2-31.60	TAK2-31.60	TAN2-31.60	TAM2-31.60	TAX2-31.60

Inserts sold in multiples of 2.

### Sub Series Holders (A, B, C, D)

Sub series holders are recommended when running carbide inserts toward the upper end of the series drill range, as well as in tougher applications requiring more insert support and holder strength. **NOTE:** Only specified sub series inserts should be used with equivalent or smaller sub series holders.



A Series Insert +  
A Series Holder



C Series Insert +  
A Series Holder



C Series Insert +  
C Series Holder



A Series Insert +  
C Series Holder

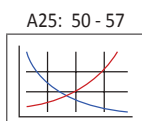
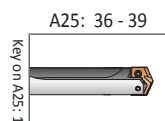

Key on A25:1

Sizes not shown are available upon request.

When ordering, please follow the example below:

<b>Metric:</b>	13.16 mm, steel, 0 series = use Part No. <b>TAP0-13.16</b>
<b>Imperial:</b>	0.5180", steel, 0 series = use Part No. <b>TAP0-13.16</b>

T-A Pro Drill Inserts

2 Series | Diameter Range: 24.38 mm - 35.04 mm (0.9597" - 1.3797")

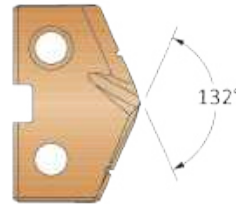

Series	Insert				Carbide				HSS
	D <sub>1</sub> mm	D <sub>1</sub> inch	Fractional Equivalent	T <sub>1</sub>	Part No. P	Part No. K	Part No. N	Part No. M	Part No. X
2-D	31.70	1.2480	—	3/16	TAP2-31.70	TAK2-31.70	TAN2-31.70	TAM2-31.70	TAX2-31.70
2-D	31.75	1.2500	1-1/4	3/16	TAP2-31.75	TAK2-31.75	TAN2-31.75	TAM2-31.75	TAX2-31.75
2-D	31.80	1.2520	—	3/16	TAP2-31.80	TAK2-31.80	TAN2-31.80	TAM2-31.80	TAX2-31.80
2-D	31.90	1.2559	—	3/16	TAP2-31.90	TAK2-31.90	TAN2-31.90	TAM2-31.90	TAX2-31.90
2-D	32.00	1.2598	—	3/16	TAP2-32.00	TAK2-32.00	TAN2-32.00	TAM2-32.00	TAX2-32.00
2-D	32.10	1.2638	—	3/16	TAP2-32.10	TAK2-32.10	TAN2-32.10	TAM2-32.10	TAX2-32.10
2-D	32.15	1.2657	1-17/64	3/16	TAP2-32.15	TAK2-32.15	TAN2-32.15	TAM2-32.15	TAX2-32.15
2-D	32.20	1.2677	—	3/16	TAP2-32.20	TAK2-32.20	TAN2-32.20	TAM2-32.20	TAX2-32.20
2-D	32.30	1.2717	—	3/16	TAP2-32.30	TAK2-32.30	TAN2-32.30	TAM2-32.30	TAX2-32.30
2-D	32.40	1.2756	—	3/16	TAP2-32.40	TAK2-32.40	TAN2-32.40	TAM2-32.40	TAX2-32.40
2-D	32.50	1.2795	—	3/16	TAP2-32.50	TAK2-32.50	TAN2-32.50	TAM2-32.50	TAX2-32.50
2-D	32.55	1.2815	1-9/32	3/16	TAP2-32.55	TAK2-32.55	TAN2-32.55	TAM2-32.55	TAX2-32.55
2-D	32.60	1.2835	—	3/16	TAP2-32.60	TAK2-32.60	TAN2-32.60	TAM2-32.60	TAX2-32.60
2-D	32.70	1.2874	—	3/16	TAP2-32.70	TAK2-32.70	TAN2-32.70	TAM2-32.70	TAX2-32.70
2-D	32.80	1.2913	—	3/16	TAP2-32.80	TAK2-32.80	TAN2-32.80	TAM2-32.80	TAX2-32.80
2-D	32.90	1.2953	—	3/16	TAP2-32.90	TAK2-32.90	TAN2-32.90	TAM2-32.90	TAX2-32.90
2-D	33.00	1.2992	—	3/16	TAP2-33.00	TAK2-33.00	TAN2-33.00	TAM2-33.00	TAX2-33.00
2-D	33.10	1.3031	—	3/16	TAP2-33.10	TAK2-33.10	TAN2-33.10	TAM2-33.10	TAX2-33.10
2-D	33.20	1.3071	—	3/16	TAP2-33.20	TAK2-33.20	TAN2-33.20	TAM2-33.20	TAX2-33.20
2-D	33.30	1.3110	—	3/16	TAP2-33.30	TAK2-33.30	TAN2-33.30	TAM2-33.30	TAX2-33.30
2-D	33.34	1.3126	1-5/16	3/16	TAP2-33.34	TAK2-33.34	TAN2-33.34	TAM2-33.34	TAX2-33.34
2-D	33.40	1.3150	—	3/16	TAP2-33.40	TAK2-33.40	TAN2-33.40	TAM2-33.40	TAX2-33.40
2-D	33.50	1.3189	—	3/16	TAP2-33.50	TAK2-33.50	TAN2-33.50	TAM2-33.50	TAX2-33.50
2-D	33.60	1.3228	—	3/16	TAP2-33.60	TAK2-33.60	TAN2-33.60	TAM2-33.60	TAX2-33.60
2-D	33.70	1.3268	—	3/16	TAP2-33.70	TAK2-33.70	TAN2-33.70	TAM2-33.70	TAX2-33.70
2-D	33.80	1.3307	—	3/16	TAP2-33.80	TAK2-33.80	TAN2-33.80	TAM2-33.80	TAX2-33.80
2-D	33.90	1.3346	—	3/16	TAP2-33.90	TAK2-33.90	TAN2-33.90	TAM2-33.90	TAX2-33.90
2-D	34.00	1.3386	—	3/16	TAP2-34.00	TAK2-34.00	TAN2-34.00	TAM2-34.00	TAX2-34.00
2-D	34.10	1.3425	—	3/16	TAP2-34.10	TAK2-34.10	TAN2-34.10	TAM2-34.10	TAX2-34.10
2-D	34.13	1.3437	1-11/32	3/16	TAP2-34.13	TAK2-34.13	TAN2-34.13	TAM2-34.13	TAX2-34.13
2-D	34.20	1.3465	—	3/16	TAP2-34.20	TAK2-34.20	TAN2-34.20	TAM2-34.20	TAX2-34.20
2-D	34.30	1.3504	—	3/16	TAP2-34.30	TAK2-34.30	TAN2-34.30	TAM2-34.30	TAX2-34.30
2-D	34.40	1.3543	—	3/16	TAP2-34.40	TAK2-34.40	TAN2-34.40	TAM2-34.40	TAX2-34.40
2-D	34.50	1.3583	—	3/16	TAP2-34.50	TAK2-34.50	TAN2-34.50	TAM2-34.50	TAX2-34.50
2-D	34.60	1.3622	—	3/16	TAP2-34.60	TAK2-34.60	TAN2-34.60	TAM2-34.60	TAX2-34.60
2-D	34.70	1.3661	—	3/16	TAP2-34.70	TAK2-34.70	TAN2-34.70	TAM2-34.70	TAX2-34.70
2-D	34.80	1.3701	—	3/16	TAP2-34.80	TAK2-34.80	TAN2-34.80	TAM2-34.80	TAX2-34.80
2-D	34.90	1.3740	—	3/16	TAP2-34.90	TAK2-34.90	TAN2-34.90	TAM2-34.90	TAX2-34.90
2-D	34.93	1.3752	1-3/8	3/16	TAP2-34.93	TAK2-34.93	TAN2-34.93	TAM2-34.93	TAX2-34.93
2-D	35.00	1.3780	—	3/16	TAP2-35.00	TAK2-35.00	TAN2-35.00	TAM2-35.00	TAX2-35.00

Inserts sold in multiples of 2.

Sub Series Holders (A, B, C, D)

Sub series holders are recommended when running carbide inserts toward the upper end of the series drill range, as well as in tougher applications requiring more insert support and holder strength. **NOTE:** Only specified sub series inserts should be used with equivalent or smaller sub series holders.



A Series Insert + A Series Holder



C Series Insert + A Series Holder



C Series Insert + C Series Holder



A Series Insert + C Series Holder

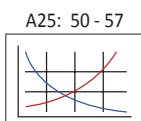
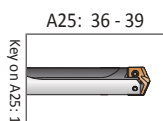

Sizes not shown are available upon request.	
When ordering, please follow the example below:	
Metric:	13.16 mm, steel, 0 series = use Part No. <b>TAP0-13.16</b>
Imperial:	0.5180", steel, 0 series = use Part No. <b>TAP0-13.16</b>

A  
DRILLING  
B  
BORING  
C  
REAMING  
D  
BURNISHING  
E  
THREADING  
X  
SPECIALS

## T-A Pro Drill Holders

2 Series Metric | Diameter Range: 24.38 mm - 35.04 mm

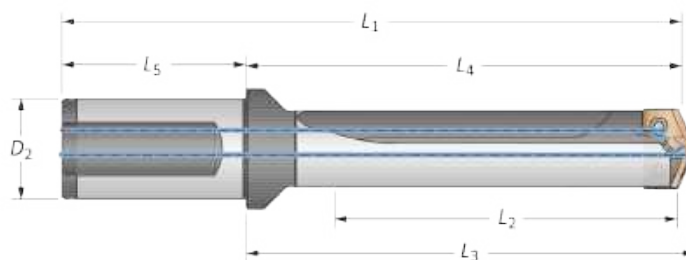

Body						Shank				Part No.
Length	Sub Series	L <sub>2</sub>	L <sub>4</sub>	L <sub>3</sub>	L <sub>1</sub>	L <sub>5</sub>	D <sub>2</sub>	Flat		
Stub	A	29.7	75.0	78.6	135.0	60.0	32	Yes	HTA2A01-32FM	
Stub	A	29.7	75.0	78.6	135.0	60.0	32	No	HTA2A01-32CM	
Stub	B	29.7	75.0	78.6	135.0	60.0	32	Yes	HTA2B01-32FM	
Stub	B	29.7	75.0	78.6	135.0	60.0	32	No	HTA2B01-32CM	
Stub	C	29.7	75.0	78.6	135.0	60.0	32	Yes	HTA2C01-32FM	
Stub	C	29.7	75.0	78.6	135.0	60.0	32	No	HTA2C01-32CM	
Stub	D	29.7	75.0	78.6	135.0	60.0	32	Yes	HTA2D01-32FM	
Stub	D	29.7	75.0	78.6	135.0	60.0	32	No	HTA2D01-32CM	
3xD	A	89.2	137.4	141.0	197.4	60.0	32	Yes	HTA2A03-32FM	
3xD	A	89.2	137.4	141.0	197.4	60.0	32	No	HTA2A03-32CM	
3xD	B	89.2	137.4	141.0	197.4	60.0	32	Yes	HTA2B03-32FM	
3xD	B	89.2	137.4	141.0	197.4	60.0	32	No	HTA2B03-32CM	
3xD	C	89.2	137.4	141.0	197.4	60.0	32	Yes	HTA2C03-32FM	
3xD	C	89.2	137.4	141.0	197.4	60.0	32	No	HTA2C03-32CM	
3xD	D	89.2	137.4	141.0	197.4	60.0	32	Yes	HTA2D03-32FM	
3xD	D	89.2	137.4	141.0	197.4	60.0	32	No	HTA2D03-32CM	
5xD	A	148.7	196.9	200.5	256.9	60.0	32	Yes	HTA2A05-32FM	
5xD	A	148.7	196.9	200.5	256.9	60.0	32	No	HTA2A05-32CM	
5xD	B	148.7	196.9	200.5	256.9	60.0	32	Yes	HTA2B05-32FM	
5xD	B	148.7	196.9	200.5	256.9	60.0	32	No	HTA2B05-32CM	
5xD	C	148.7	196.9	200.5	256.9	60.0	32	Yes	HTA2C05-32FM	
5xD	C	148.7	196.9	200.5	256.9	60.0	32	No	HTA2C05-32CM	
5xD	D	148.7	196.9	200.5	256.9	60.0	32	Yes	HTA2D05-32FM	
5xD	D	148.7	196.9	200.5	256.9	60.0	32	No	HTA2D05-32CM	
7xD	A	208.2	256.4	260.0	316.4	60.0	32	Yes	HTA2A07-32FM	
7xD	A	208.2	256.4	260.0	316.4	60.0	32	No	HTA2A07-32CM	
7xD	B	208.2	256.4	260.0	316.4	60.0	32	Yes	HTA2B07-32FM	
7xD	B	208.2	256.4	260.0	316.4	60.0	32	No	HTA2B07-32CM	
7xD	C	208.2	256.4	260.0	316.4	60.0	32	Yes	HTA2C07-32FM	
7xD	C	208.2	256.4	260.0	316.4	60.0	32	No	HTA2C07-32CM	
7xD	D	208.2	256.4	260.0	316.4	60.0	32	Yes	HTA2D07-32FM	
7xD	D	208.2	256.4	260.0	316.4	60.0	32	No	HTA2D07-32CM	

Sub Series	2 Series Holder Diameter Range	
	Metric (mm)	Imperial (inch)
2A	24.38 mm - 35.04 mm	0.9597" - 1.3797"
2B	25.40 mm - 35.04 mm	0.9999" - 1.3797"
2C	28.50 mm - 35.04 mm	1.1219" - 1.3797"
2D	31.70 mm - 35.04 mm	1.2479" - 1.3797"

### Connection Accessories

Insert Screws	Nylon Locking Screws	Insert Driver	Preset Torque Hand Driver	Replacement Tips	Admissible Tightening Torque*
7495-IP15-1	7495N-IP15-1	8IP-15	8IP-15TL	8IP-15B	690 N-cm (61.0 in-lbs)

\*Tightening torques are calculated with a friction coefficient of  $\mu = 0.14$  and develop 90% of ultimate yield strength.

**1. WARNING** Refer to Speed and Feed charts for recommended adjustments to speeds and feeds. Refer to page A25: 60 for deep hole drilling guidelines in this section of the catalogue. Visit [www.alliedmachine.com/DeepHoleGuidelines](http://www.alliedmachine.com/DeepHoleGuidelines) for the most up-to-date information and procedures. Factory technical assistance is available for your specific applications through our Application Engineering department.  
email: [engineering.eu@alliedmachine.com](mailto:engineering.eu@alliedmachine.com)

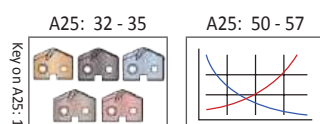

Ⓜ = Metric (mm)  
Ⓢ = Imperial (in)

Screws sold in multiples of 10.



## T-A Pro Drill Holders

2 Series Metric | Diameter Range: 24.38 mm - 35.04 mm

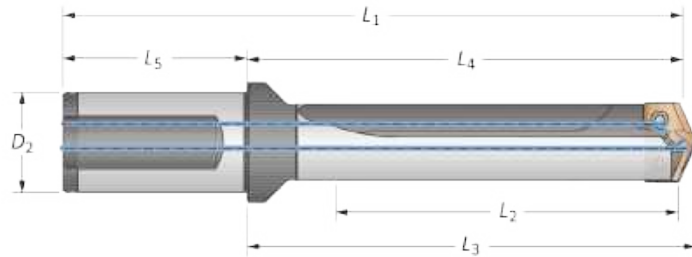

Length	Sub Series	Body				Shank				Part No.
		L <sub>2</sub>	L <sub>4</sub>	L <sub>3</sub>	L <sub>1</sub>	L <sub>5</sub>	D <sub>2</sub>	Flat		
10xD	A	297.4	345.6	349.2	405.6	60.0	32	Yes	⚠ HTA2A10-32FM	
10xD	A	297.4	345.6	349.2	405.6	60.0	32	No	⚠ HTA2A10-32CM	
10xD	B	297.4	345.6	349.2	405.6	60.0	32	Yes	⚠ HTA2B10-32FM	
10xD	B	297.4	345.6	349.2	405.6	60.0	32	No	⚠ HTA2B10-32CM	
10xD	C	297.4	345.6	349.2	405.6	60.0	32	Yes	⚠ HTA2C10-32FM	
10xD	C	297.4	345.6	349.2	405.6	60.0	32	No	⚠ HTA2C10-32CM	
10xD	D	297.4	345.6	349.2	405.6	60.0	32	Yes	⚠ HTA2D10-32FM	
10xD	D	297.4	345.6	349.2	405.6	60.0	32	No	⚠ HTA2D10-32CM	
12xD	A	356.9	405.1	408.7	465.1	60.0	32	Yes	⚠ HTA2A12-32FM	
12xD	A	356.9	405.1	408.7	465.1	60.0	32	No	⚠ HTA2A12-32CM	
12xD	B	356.9	405.1	408.7	465.1	60.0	32	Yes	⚠ HTA2B12-32FM	
12xD	B	356.9	405.1	408.7	465.1	60.0	32	No	⚠ HTA2B12-32CM	
12xD	C	356.9	405.1	408.7	465.1	60.0	32	Yes	⚠ HTA2C12-32FM	
12xD	C	356.9	405.1	408.7	465.1	60.0	32	No	⚠ HTA2C12-32CM	
12xD	D	356.9	405.1	408.7	465.1	60.0	32	Yes	⚠ HTA2D12-32FM	
12xD	D	356.9	405.1	408.7	465.1	60.0	32	No	⚠ HTA2D12-32CM	
15xD	A	446.2	494.4	497.9	554.4	60.0	32	Yes	⚠ HTA2A15-32FM	
15xD	A	446.2	494.4	497.9	554.4	60.0	32	No	⚠ HTA2A15-32CM	
15xD	B	446.2	494.4	497.9	554.4	60.0	32	Yes	⚠ HTA2B15-32FM	
15xD	B	446.2	494.4	497.9	554.4	60.0	32	No	⚠ HTA2B15-32CM	
15xD	C	446.2	494.4	497.9	554.4	60.0	32	Yes	⚠ HTA2C15-32FM	
15xD	C	446.2	494.4	497.9	554.4	60.0	32	No	⚠ HTA2C15-32CM	
15xD	D	446.2	494.4	497.9	554.4	60.0	32	Yes	⚠ HTA2D15-32FM	
15xD	D	446.2	494.4	497.9	554.4	60.0	32	No	⚠ HTA2D15-32CM	

Ⓜ

A

DRILLING

B

BORING

C

REAMING

D

BURNISHING

F

THREADING

X

SPECIALS

Sub Series	2 Series Holder Diameter Range	
	Metric (mm)	Imperial (inch)
2A	24.38 mm - 35.04 mm	0.9597" - 1.3797"
2B	25.40 mm - 35.04 mm	0.9999" - 1.3797"
2C	28.50 mm - 35.04 mm	1.1219" - 1.3797"
2D	31.70 mm - 35.04 mm	1.2479" - 1.3797"

### Connection Accessories

Insert Screws	Nylon Locking Screws	Insert Driver	Preset Torque Hand Driver	Replacement Tips	Admissible Tightening Torque*
7495-IP15-1	7495N-IP15-1	8IP-15	8IP-15TL	8IP-15B	690 N-cm (61.0 in-lbs)

\*Tightening torques are calculated with a friction coefficient of  $\mu = 0.14$  and develop 90% of ultimate yield strength.

**⚠ WARNING** Refer to Speed and Feed charts for recommended adjustments to speeds and feeds. Refer to page A25: 60 for deep hole drilling guidelines in this section of the catalogue. Visit [www.alliedmachine.com/DeepHoleGuidelines](http://www.alliedmachine.com/DeepHoleGuidelines) for the most up-to-date information and procedures. Factory technical assistance is available for your specific applications through our Application Engineering department.  
email: [engineering.eu@alliedmachine.com](mailto:engineering.eu@alliedmachine.com)

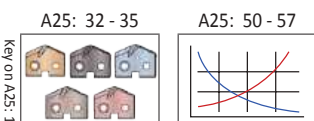

Ⓜ = Metric (mm)  
Ⓜ = Imperial (in)

Screws sold in multiples of 10.

## T-A Pro Drill Holders

2 Series Imperial | Diameter Range: 0.9597" - 1.3797"

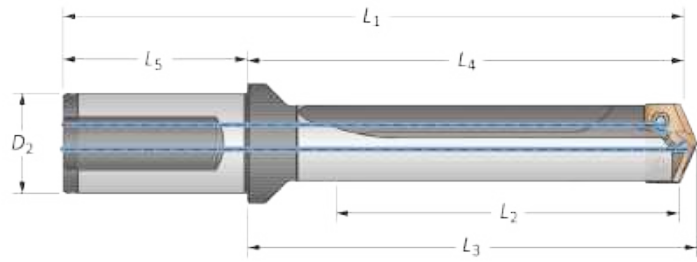

Body						Shank			Flat	Part No.
Length	Sub Series	L <sub>2</sub>	L <sub>4</sub>	L <sub>3</sub>	L <sub>1</sub>	L <sub>5</sub>	D <sub>2</sub>			
Stub	A	1.171	2.954	3.094	5.234	2.280	1-1/4	Yes	HTA2A01-125F	
Stub	A	1.171	2.954	3.094	5.234	2.280	1-1/4	No	HTA2A01-125C	
Stub	B	1.171	2.954	3.094	5.234	2.280	1-1/4	Yes	HTA2B01-125F	
Stub	B	1.171	2.954	3.094	5.234	2.280	1-1/4	No	HTA2B01-125C	
Stub	C	1.171	2.954	3.094	5.234	2.280	1-1/4	Yes	HTA2C01-125F	
Stub	C	1.171	2.954	3.094	5.234	2.280	1-1/4	No	HTA2C01-125C	
Stub	D	1.171	2.954	3.094	5.234	2.280	1-1/4	Yes	HTA2D01-125F	
Stub	D	1.171	2.954	3.094	5.234	2.280	1-1/4	No	HTA2D01-125C	
3xD	A	3.513	5.411	5.551	7.691	2.280	1-1/4	Yes	HTA2A03-125F	
3xD	A	3.513	5.411	5.551	7.691	2.280	1-1/4	No	HTA2A03-125C	
3xD	B	3.513	5.411	5.551	7.691	2.280	1-1/4	Yes	HTA2B03-125F	
3xD	B	3.513	5.411	5.551	7.691	2.280	1-1/4	No	HTA2B03-125C	
3xD	C	3.513	5.411	5.551	7.691	2.280	1-1/4	Yes	HTA2C03-125F	
3xD	C	3.513	5.411	5.551	7.691	2.280	1-1/4	No	HTA2C03-125C	
3xD	D	3.513	5.411	5.551	7.691	2.280	1-1/4	Yes	HTA2D03-125F	
3xD	D	3.513	5.411	5.551	7.691	2.280	1-1/4	No	HTA2D03-125C	
5xD	A	5.855	7.753	7.893	10.033	2.280	1-1/4	Yes	HTA2A05-125F	
5xD	A	5.855	7.753	7.893	10.033	2.280	1-1/4	No	HTA2A05-125C	
5xD	B	5.855	7.753	7.893	10.033	2.280	1-1/4	Yes	HTA2B05-125F	
5xD	B	5.855	7.753	7.893	10.033	2.280	1-1/4	No	HTA2B05-125C	
5xD	C	5.855	7.753	7.893	10.033	2.280	1-1/4	Yes	HTA2C05-125F	
5xD	C	5.855	7.753	7.893	10.033	2.280	1-1/4	No	HTA2C05-125C	
5xD	D	5.855	7.753	7.893	10.033	2.280	1-1/4	Yes	HTA2D05-125F	
5xD	D	5.855	7.753	7.893	10.033	2.280	1-1/4	No	HTA2D05-125C	
7xD	A	8.197	10.095	10.235	12.375	2.280	1-1/4	Yes	HTA2A07-125F	
7xD	A	8.197	10.095	10.235	12.375	2.280	1-1/4	No	HTA2A07-125C	
7xD	B	8.197	10.095	10.235	12.375	2.280	1-1/4	Yes	HTA2B07-125F	
7xD	B	8.197	10.095	10.235	12.375	2.280	1-1/4	No	HTA2B07-125C	
7xD	C	8.197	10.095	10.235	12.375	2.280	1-1/4	Yes	HTA2C07-125F	
7xD	C	8.197	10.095	10.235	12.375	2.280	1-1/4	No	HTA2C07-125C	
7xD	D	8.197	10.095	10.235	12.375	2.280	1-1/4	Yes	HTA2D07-125F	
7xD	D	8.197	10.095	10.235	12.375	2.280	1-1/4	No	HTA2D07-125C	

1

Sub Series	2 Series Holder Diameter Range	
	Metric (mm)	Imperial (inch)
2A	24.38 mm - 35.04 mm	0.9597" - 1.3797"
2B	25.40 mm - 35.04 mm	0.9999" - 1.3797"
2C	28.50 mm - 35.04 mm	1.1219" - 1.3797"
2D	31.70 mm - 35.04 mm	1.2479" - 1.3797"

### Connection Accessories

Insert Screws	Nylon Locking Screws	Insert Driver	Preset Torque Hand Driver	Replacement Tips	Admissible Tightening Torque*
7495-IP15-1	7495N-IP15-1	8IP-15	8IP-15TL	8IP-15B	690 N-cm (61.0 in-lbs)

\*Tightening torques are calculated with a friction coefficient of  $\mu = 0.14$  and develop 90% of ultimate yield strength.

**1. WARNING** Refer to Speed and Feed charts for recommended adjustments to speeds and feeds. Refer to page **A25: 60** for deep hole drilling guidelines in this section of the catalogue. Visit [www.alliedmachine.com/DeepHoleGuidelines](http://www.alliedmachine.com/DeepHoleGuidelines) for the most up-to-date information and procedures. Factory technical assistance is available for your specific applications through our Application Engineering department.  
email: [engineering.eu@alliedmachine.com](mailto:engineering.eu@alliedmachine.com)

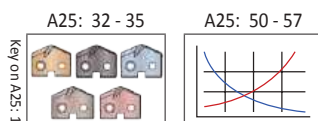

Ⓜ = Metric (mm)  
Ⓜ = Imperial (in)

Screws sold in multiples of 10.



T-A Pro Drill Holders

2 Series Imperial | Diameter Range: 0.9597" - 1.3797"

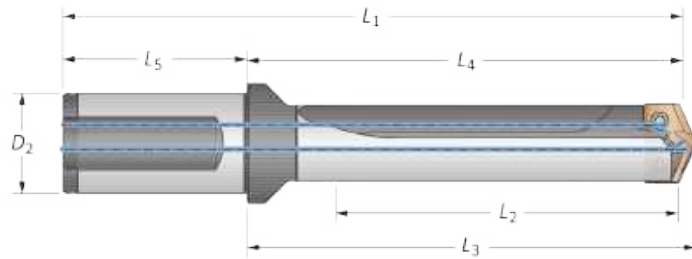

Body						Shank				Part No.
Length	Sub Series	L <sub>2</sub>	L <sub>4</sub>	L <sub>3</sub>	L <sub>1</sub>	L <sub>5</sub>	D <sub>2</sub>	Flat		
10xD	A	11.710	13.608	13.748	15.888	2.280	1-1/4	Yes	HTA2A10-125F	
10xD	A	11.710	13.608	13.748	15.888	2.280	1-1/4	No	HTA2A10-125C	
10xD	B	11.710	13.608	13.748	15.888	2.280	1-1/4	Yes	HTA2B10-125F	
10xD	B	11.710	13.608	13.748	15.888	2.280	1-1/4	No	HTA2B10-125C	
10xD	C	11.710	13.608	13.748	15.888	2.280	1-1/4	Yes	HTA2C10-125F	
10xD	C	11.710	13.608	13.748	15.888	2.280	1-1/4	No	HTA2C10-125C	
10xD	D	11.710	13.608	13.748	15.888	2.280	1-1/4	Yes	HTA2D10-125F	
10xD	D	11.710	13.608	13.748	15.888	2.280	1-1/4	No	HTA2D10-125C	
12xD	A	14.052	15.950	16.090	18.230	2.280	1-1/4	Yes	HTA2A12-125F	
12xD	A	14.052	15.950	16.090	18.230	2.280	1-1/4	No	HTA2A12-125C	
12xD	B	14.052	15.950	16.090	18.230	2.280	1-1/4	Yes	HTA2B12-125F	
12xD	B	14.052	15.950	16.090	18.230	2.280	1-1/4	No	HTA2B12-125C	
12xD	C	14.052	15.950	16.090	18.230	2.280	1-1/4	Yes	HTA2C12-125F	
12xD	C	14.052	15.950	16.090	18.230	2.280	1-1/4	No	HTA2C12-125C	
12xD	D	14.052	15.950	16.090	18.230	2.280	1-1/4	Yes	HTA2D12-125F	
12xD	D	14.052	15.950	16.090	18.230	2.280	1-1/4	No	HTA2D12-125C	
15xD	A	17.565	19.463	19.603	21.743	2.280	1-1/4	Yes	HTA2A15-125F	
15xD	A	17.565	19.463	19.603	21.743	2.280	1-1/4	No	HTA2A15-125C	
15xD	B	17.565	19.463	19.603	21.743	2.280	1-1/4	Yes	HTA2B15-125F	
15xD	B	17.565	19.463	19.603	21.743	2.280	1-1/4	No	HTA2B15-125C	
15xD	C	17.565	19.463	19.603	21.743	2.280	1-1/4	Yes	HTA2C15-125F	
15xD	C	17.565	19.463	19.603	21.743	2.280	1-1/4	No	HTA2C15-125C	
15xD	D	17.565	19.463	19.603	21.743	2.280	1-1/4	Yes	HTA2D15-125F	
15xD	D	17.565	19.463	19.603	21.743	2.280	1-1/4	No	HTA2D15-125C	

1

A  
DRILLING  
B  
BORING  
C  
REAMING  
D  
BURNISHING  
E  
THREADING  
F  
SPECIALS

Sub Series	2 Series Holder Diameter Range	
	Metric (mm)	Imperial (inch)
2A	24.38 mm - 35.04 mm	0.9597" - 1.3797"
2B	25.40 mm - 35.04 mm	0.9999" - 1.3797"
2C	28.50 mm - 35.04 mm	1.1219" - 1.3797"
2D	31.70 mm - 35.04 mm	1.2479" - 1.3797"

Connection Accessories

					Admissible Tightening Torque*
7495-IP15-1	7495N-IP15-1	8IP-15	8IP-15TL	8IP-15B	

\*Tightening torques are calculated with a friction coefficient of  $\mu = 0.14$  and develop 90% of ultimate yield strength.

**1. WARNING** Refer to Speed and Feed charts for recommended adjustments to speeds and feeds. Refer to page A25: 60 for deep hole drilling guidelines in this section of the catalogue. Visit [www.alliedmachine.com/DeepHoleGuidelines](http://www.alliedmachine.com/DeepHoleGuidelines) for the most up-to-date information and procedures. Factory technical assistance is available for your specific applications through our Application Engineering department.  
email: [engineering.eu@alliedmachine.com](mailto:engineering.eu@alliedmachine.com)





A25: 32 - 35      A25: 50 - 57

Ⓜ = Metric (mm)  
Ⓢ = Imperial (in)  
Screws sold in multiples of 10.

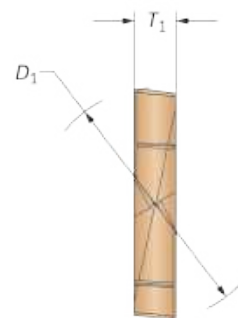
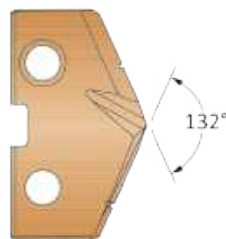
## T-A Pro Drill Inserts

3 Series | Diameter Range: 35.05 mm - 47.80 mm (1.3798" - 1.8820")



Insert					Carbide				HSS
Series	D <sub>1</sub> mm	D <sub>1</sub> inch	Fractional Equivalent	T <sub>1</sub>					
					Part No.	Part No.	Part No.	Part No.	Part No.
3-A	35.10	1.3819	—	1/4	TAP3-35.10	TAK3-35.10	TAN3-35.10	TAM3-35.10	TAX3-35.10
3-A	35.20	1.3858	—	1/4	TAP3-35.20	TAK3-35.20	TAN3-35.20	TAM3-35.20	TAX3-35.20
3-A	35.30	1.3898	—	1/4	TAP3-35.30	TAK3-35.30	TAN3-35.30	TAM3-35.30	TAX3-35.30
3-A	35.40	1.3937	—	1/4	TAP3-35.40	TAK3-35.40	TAN3-35.40	TAM3-35.40	TAX3-35.40
3-A	35.50	1.3976	—	1/4	TAP3-35.50	TAK3-35.50	TAN3-35.50	TAM3-35.50	TAX3-35.50
3-A	35.60	1.4016	—	1/4	TAP3-35.60	TAK3-35.60	TAN3-35.60	TAM3-35.60	TAX3-35.60
3-A	35.70	1.4055	—	1/4	TAP3-35.70	TAK3-35.70	TAN3-35.70	TAM3-35.70	TAX3-35.70
3-A	35.72	1.4063	1-13/32	1/4	TAP3-35.72	TAK3-35.72	TAN3-35.72	TAM3-35.72	TAX3-35.72
3-A	35.80	1.4094	—	1/4	TAP3-35.80	TAK3-35.80	TAN3-35.80	TAM3-35.80	TAX3-35.80
3-A	35.90	1.4134	—	1/4	TAP3-35.90	TAK3-35.90	TAN3-35.90	TAM3-35.90	TAX3-35.90
3-A	36.00	1.4173	—	1/4	TAP3-36.00	TAK3-36.00	TAN3-36.00	TAM3-36.00	TAX3-36.00
3-A	36.10	1.4213	—	1/4	TAP3-36.10	TAK3-36.10	TAN3-36.10	TAM3-36.10	TAX3-36.10
3-A	36.20	1.4252	—	1/4	TAP3-36.20	TAK3-36.20	TAN3-36.20	TAM3-36.20	TAX3-36.20
3-A	36.30	1.4291	—	1/4	TAP3-36.30	TAK3-36.30	TAN3-36.30	TAM3-36.30	TAX3-36.30
3-A	36.40	1.4331	—	1/4	TAP3-36.40	TAK3-36.40	TAN3-36.40	TAM3-36.40	TAX3-36.40
3-A	36.50	1.4370	—	1/4	TAP3-36.50	TAK3-36.50	TAN3-36.50	TAM3-36.50	TAX3-36.50
3-A	36.51	1.4374	1-7/16	1/4	TAP3-36.51	TAK3-36.51	TAN3-36.51	TAM3-36.51	TAX3-36.51
3-A	36.60	1.4409	—	1/4	TAP3-36.60	TAK3-36.60	TAN3-36.60	TAM3-36.60	TAX3-36.60
3-A	36.70	1.4449	—	1/4	TAP3-36.70	TAK3-36.70	TAN3-36.70	TAM3-36.70	TAX3-36.70
3-A	36.80	1.4488	—	1/4	TAP3-36.80	TAK3-36.80	TAN3-36.80	TAM3-36.80	TAX3-36.80
3-A	36.90	1.4528	—	1/4	TAP3-36.90	TAK3-36.90	TAN3-36.90	TAM3-36.90	TAX3-36.90
3-A	37.00	1.4567	—	1/4	TAP3-37.00	TAK3-37.00	TAN3-37.00	TAM3-37.00	TAX3-37.00
3-A	37.10	1.4606	—	1/4	TAP3-37.10	TAK3-37.10	TAN3-37.10	TAM3-37.10	TAX3-37.10
3-A	37.20	1.4646	—	1/4	TAP3-37.20	TAK3-37.20	TAN3-37.20	TAM3-37.20	TAX3-37.20
3-A	37.30	1.4685	—	1/4	TAP3-37.30	TAK3-37.30	TAN3-37.30	TAM3-37.30	TAX3-37.30
3-A	37.31	1.4689	1-15/32	1/4	TAP3-37.31	TAK3-37.31	TAN3-37.31	TAM3-37.31	TAX3-37.31
3-A	37.40	1.4724	—	1/4	TAP3-37.40	TAK3-37.40	TAN3-37.40	TAM3-37.40	TAX3-37.40
3-A	37.50	1.4764	—	1/4	TAP3-37.50	TAK3-37.50	TAN3-37.50	TAM3-37.50	TAX3-37.50
3-A	37.60	1.4803	—	1/4	TAP3-37.60	TAK3-37.60	TAN3-37.60	TAM3-37.60	TAX3-37.60
3-A	37.70	1.4843	1-31/64	1/4	TAP3-37.70	TAK3-37.70	TAN3-37.70	TAM3-37.70	TAX3-37.70

Inserts sold in multiples of 1.

### Sub Series Holders (A, B, C, D)

Sub series holders are recommended when running carbide inserts toward the upper end of the series drill range, as well as in tougher applications requiring more insert support and holder strength. **NOTE:** Only specified sub series inserts should be used with equivalent or smaller sub series holders.



A Series Insert +  
A Series Holder



C Series Insert +  
A Series Holder



C Series Insert +  
C Series Holder



A Series Insert +  
C Series Holder

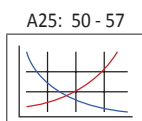
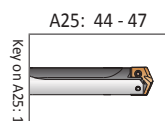

Key on A25: 1

Sizes not shown are available upon request.





When ordering, please follow the example below:

<b>Metric:</b>	13.16 mm, steel, 0 series = use Part No. <b>TAP0-13.16</b>
<b>Imperial:</b>	0.5180", steel, 0 series = use Part No. <b>TAP0-13.16</b>

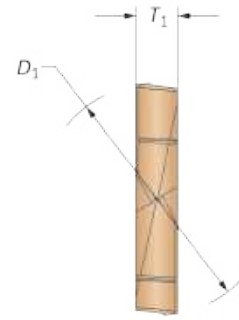
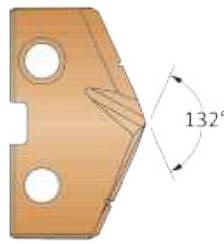
T-A Pro Drill Inserts

3 Series | Diameter Range: 35.05 mm - 47.80 mm (1.3798" - 1.8820")



Insert					Carbide				HSS
Series	D <sub>1</sub> mm	D <sub>1</sub> inch	Fractional Equivalent	T <sub>1</sub>					
					P	K	N	M	X
3-B	37.80	1.4882	—	1/4	TAP3-37.80	TAK3-37.80	TAN3-37.80	TAM3-37.80	TAX3-37.80
3-B	37.90	1.4921	—	1/4	TAP3-37.90	TAK3-37.90	TAN3-37.90	TAM3-37.90	TAX3-37.90
3-B	38.00	1.4961	—	1/4	TAP3-38.00	TAK3-38.00	TAN3-38.00	TAM3-38.00	TAX3-38.00
3-B	38.10	1.5000	1-1/2	1/4	TAP3-38.10	TAK3-38.10	TAN3-38.10	TAM3-38.10	TAX3-38.10
3-B	38.20	1.5039	—	1/4	TAP3-38.20	TAK3-38.20	TAN3-38.20	TAM3-38.20	TAX3-38.20
3-B	38.30	1.5079	—	1/4	TAP3-38.30	TAK3-38.30	TAN3-38.30	TAM3-38.30	TAX3-38.30
3-B	38.40	1.5118	—	1/4	TAP3-38.40	TAK3-38.40	TAN3-38.40	TAM3-38.40	TAX3-38.40
3-B	38.50	1.5157	1-33/64	1/4	TAP3-38.50	TAK3-38.50	TAN3-38.50	TAM3-38.50	TAX3-38.50
3-B	38.60	1.5197	—	1/4	TAP3-38.60	TAK3-38.60	TAN3-38.60	TAM3-38.60	TAX3-38.60
3-B	38.70	1.5236	—	1/4	TAP3-38.70	TAK3-38.70	TAN3-38.70	TAM3-38.70	TAX3-38.70
3-B	38.80	1.5276	—	1/4	TAP3-38.80	TAK3-38.80	TAN3-38.80	TAM3-38.80	TAX3-38.80
3-B	38.89	1.5311	1-17/32	1/4	TAP3-38.89	TAK3-38.89	TAN3-38.89	TAM3-38.89	TAX3-38.89
3-B	38.90	1.5315	—	1/4	TAP3-38.90	TAK3-38.90	TAN3-38.90	TAM3-38.90	TAX3-38.90
3-B	39.00	1.5354	—	1/4	TAP3-39.00	TAK3-39.00	TAN3-39.00	TAM3-39.00	TAX3-39.00
3-B	39.10	1.5394	—	1/4	TAP3-39.10	TAK3-39.10	TAN3-39.10	TAM3-39.10	TAX3-39.10
3-B	39.20	1.5433	—	1/4	TAP3-39.20	TAK3-39.20	TAN3-39.20	TAM3-39.20	TAX3-39.20
3-B	39.29	1.5469	1-35/64	1/4	TAP3-39.29	TAK3-39.29	TAN3-39.29	TAM3-39.29	TAX3-39.29
3-B	39.30	1.5472	—	1/4	TAP3-39.30	TAK3-39.30	TAN3-39.30	TAM3-39.30	TAX3-39.30
3-B	39.40	1.5512	—	1/4	TAP3-39.40	TAK3-39.40	TAN3-39.40	TAM3-39.40	TAX3-39.40
3-B	39.50	1.5551	—	1/4	TAP3-39.50	TAK3-39.50	TAN3-39.50	TAM3-39.50	TAX3-39.50
3-B	39.60	1.5591	—	1/4	TAP3-39.60	TAK3-39.60	TAN3-39.60	TAM3-39.60	TAX3-39.60
3-B	39.69	1.5626	1-9/16	1/4	TAP3-39.69	TAK3-39.69	TAN3-39.69	TAM3-39.69	TAX3-39.69
3-B	39.70	1.5630	—	1/4	TAP3-39.70	TAK3-39.70	TAN3-39.70	TAM3-39.70	TAX3-39.70
3-B	39.80	1.5669	—	1/4	TAP3-39.80	TAK3-39.80	TAN3-39.80	TAM3-39.80	TAX3-39.80
3-B	39.90	1.5709	—	1/4	TAP3-39.90	TAK3-39.90	TAN3-39.90	TAM3-39.90	TAX3-39.90
3-B	40.00	1.5748	—	1/4	TAP3-40.00	TAK3-40.00	TAN3-40.00	TAM3-40.00	TAX3-40.00
3-B	40.10	1.5787	—	1/4	TAP3-40.10	TAK3-40.10	TAN3-40.10	TAM3-40.10	TAX3-40.10
3-B	40.20	1.5827	—	1/4	TAP3-40.20	TAK3-40.20	TAN3-40.20	TAM3-40.20	TAX3-40.20
3-B	40.30	1.5866	—	1/4	TAP3-40.30	TAK3-40.30	TAN3-40.30	TAM3-40.30	TAX3-40.30
3-B	40.40	1.5906	—	1/4	TAP3-40.40	TAK3-40.40	TAN3-40.40	TAM3-40.40	TAX3-40.40
3-B	40.48	1.5937	1-19/32	1/4	TAP3-40.48	TAK3-40.48	TAN3-40.48	TAM3-40.48	TAX3-40.48
3-B	40.50	1.5945	—	1/4	TAP3-40.50	TAK3-40.50	TAN3-40.50	TAM3-40.50	TAX3-40.50
3-B	40.60	1.5984	—	1/4	TAP3-40.60	TAK3-40.60	TAN3-40.60	TAM3-40.60	TAX3-40.60
3-B	40.70	1.6024	—	1/4	TAP3-40.70	TAK3-40.70	TAN3-40.70	TAM3-40.70	TAX3-40.70
3-B	40.80	1.6063	—	1/4	TAP3-40.80	TAK3-40.80	TAN3-40.80	TAM3-40.80	TAX3-40.80
3-B	40.90	1.6102	—	1/4	TAP3-40.90	TAK3-40.90	TAN3-40.90	TAM3-40.90	TAX3-40.90

Inserts sold in multiples of 1.

Sub Series Holders (A, B, C, D)

Sub series holders are recommended when running carbide inserts toward the upper end of the series drill range, as well as in tougher applications requiring more insert support and holder strength. **NOTE:** Only specified sub series inserts should be used with equivalent or smaller sub series holders.



A Series Insert + A Series Holder



C Series Insert + A Series Holder



C Series Insert + C Series Holder



A Series Insert + C Series Holder

A25: 44 - 47

A25: 50 - 57

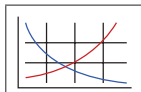
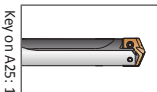

Sizes not shown are available upon request.

When ordering, please follow the example below:





Metric:	13.16 mm, steel, 0 series = use Part No. TAP0-13.16
Imperial:	0.5180", steel, 0 series = use Part No. TAP0-13.16

A  
DRILLING  
B  
BORING  
C  
REAMING  
D  
BURISHING  
E  
THREADING  
X  
SPECIALS

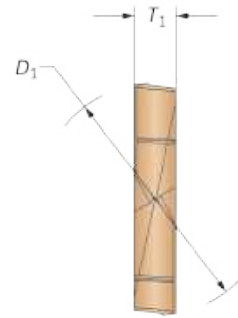
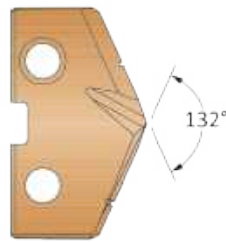
## T-A Pro Drill Inserts

3 Series | Diameter Range: 35.05 mm - 47.80 mm (1.3798" - 1.8820")



Insert					Carbide				HSS
Series	D <sub>1</sub> mm	D <sub>1</sub> inch	Fractional Equivalent	T <sub>1</sub>					
					Part No.	Part No.	Part No.	Part No.	Part No.
3-C	41.00	1.6142	—	1/4	TAP3-41.00	TAK3-41.00	TAN3-41.00	TAM3-41.00	TAX3-41.00
3-C	41.10	1.6181	—	1/4	TAP3-41.10	TAK3-41.10	TAN3-41.10	TAM3-41.10	TAX3-41.10
3-C	41.20	1.6220	—	1/4	TAP3-41.20	TAK3-41.20	TAN3-41.20	TAM3-41.20	TAX3-41.20
3-C	41.28	1.6252	1-5/8	1/4	TAP3-41.28	TAK3-41.28	TAN3-41.28	TAM3-41.28	TAX3-41.28
3-C	41.30	1.6260	—	1/4	TAP3-41.30	TAK3-41.30	TAN3-41.30	TAM3-41.30	TAX3-41.30
3-C	41.40	1.6299	—	1/4	TAP3-41.40	TAK3-41.40	TAN3-41.40	TAM3-41.40	TAX3-41.40
3-C	41.50	1.6339	—	1/4	TAP3-41.50	TAK3-41.50	TAN3-41.50	TAM3-41.50	TAX3-41.50
3-C	41.60	1.6378	—	1/4	TAP3-41.60	TAK3-41.60	TAN3-41.60	TAM3-41.60	TAX3-41.60
3-C	41.70	1.6417	—	1/4	TAP3-41.70	TAK3-41.70	TAN3-41.70	TAM3-41.70	TAX3-41.70
3-C	41.80	1.6457	—	1/4	TAP3-41.80	TAK3-41.80	TAN3-41.80	TAM3-41.80	TAX3-41.80
3-C	41.90	1.6496	—	1/4	TAP3-41.90	TAK3-41.90	TAN3-41.90	TAM3-41.90	TAX3-41.90
3-C	42.00	1.6535	—	1/4	TAP3-42.00	TAK3-42.00	TAN3-42.00	TAM3-42.00	TAX3-42.00
3-C	42.07	1.6563	1-21/32	1/4	TAP3-42.07	TAK3-42.07	TAN3-42.07	TAM3-42.07	TAX3-42.07
3-C	42.10	1.6575	—	1/4	TAP3-42.10	TAK3-42.10	TAN3-42.10	TAM3-42.10	TAX3-42.10
3-C	42.20	1.6614	—	1/4	TAP3-42.20	TAK3-42.20	TAN3-42.20	TAM3-42.20	TAX3-42.20
3-C	42.30	1.6654	—	1/4	TAP3-42.30	TAK3-42.30	TAN3-42.30	TAM3-42.30	TAX3-42.30
3-C	42.40	1.6693	—	1/4	TAP3-42.40	TAK3-42.40	TAN3-42.40	TAM3-42.40	TAX3-42.40
3-C	42.50	1.6732	—	1/4	TAP3-42.50	TAK3-42.50	TAN3-42.50	TAM3-42.50	TAX3-42.50
3-C	42.60	1.6772	—	1/4	TAP3-42.60	TAK3-42.60	TAN3-42.60	TAM3-42.60	TAX3-42.60
3-C	42.70	1.6811	—	1/4	TAP3-42.70	TAK3-42.70	TAN3-42.70	TAM3-42.70	TAX3-42.70
3-C	42.80	1.6850	—	1/4	TAP3-42.80	TAK3-42.80	TAN3-42.80	TAM3-42.80	TAX3-42.80
3-C	42.86	1.6874	1-11/16	1/4	TAP3-42.86	TAK3-42.86	TAN3-42.86	TAM3-42.86	TAX3-42.86
3-C	42.90	1.6890	—	1/4	TAP3-42.90	TAK3-42.90	TAN3-42.90	TAM3-42.90	TAX3-42.90
3-C	43.00	1.6929	—	1/4	TAP3-43.00	TAK3-43.00	TAN3-43.00	TAM3-43.00	TAX3-43.00
3-C	43.10	1.6969	—	1/4	TAP3-43.10	TAK3-43.10	TAN3-43.10	TAM3-43.10	TAX3-43.10
3-C	43.20	1.7008	—	1/4	TAP3-43.20	TAK3-43.20	TAN3-43.20	TAM3-43.20	TAX3-43.20
3-C	43.30	1.7047	—	1/4	TAP3-43.30	TAK3-43.30	TAN3-43.30	TAM3-43.30	TAX3-43.30
3-C	43.40	1.7087	—	1/4	TAP3-43.40	TAK3-43.40	TAN3-43.40	TAM3-43.40	TAX3-43.40
3-C	43.50	1.7126	—	1/4	TAP3-43.50	TAK3-43.50	TAN3-43.50	TAM3-43.50	TAX3-43.50
3-C	43.60	1.7165	—	1/4	TAP3-43.60	TAK3-43.60	TAN3-43.60	TAM3-43.60	TAX3-43.60
3-C	43.66	1.7189	1-23/32	1/4	TAP3-43.66	TAK3-43.66	TAN3-43.66	TAM3-43.66	TAX3-43.66
3-C	43.70	1.7205	—	1/4	TAP3-43.70	TAK3-43.70	TAN3-43.70	TAM3-43.70	TAX3-43.70
3-C	43.80	1.7244	—	1/4	TAP3-43.80	TAK3-43.80	TAN3-43.80	TAM3-43.80	TAX3-43.80
3-C	43.90	1.7283	—	1/4	TAP3-43.90	TAK3-43.90	TAN3-43.90	TAM3-43.90	TAX3-43.90
3-C	44.00	1.7323	—	1/4	TAP3-44.00	TAK3-44.00	TAN3-44.00	TAM3-44.00	TAX3-44.00
3-C	44.10	1.7362	—	1/4	TAP3-44.10	TAK3-44.10	TAN3-44.10	TAM3-44.10	TAX3-44.10
3-C	44.20	1.7402	—	1/4	TAP3-44.20	TAK3-44.20	TAN3-44.20	TAM3-44.20	TAX3-44.20
3-C	44.30	1.7441	—	1/4	TAP3-44.30	TAK3-44.30	TAN3-44.30	TAM3-44.30	TAX3-44.30

Inserts sold in multiples of 1.

### Sub Series Holders (A, B, C, D)

Sub series holders are recommended when running carbide inserts toward the upper end of the series drill range, as well as in tougher applications requiring more insert support and holder strength. **NOTE:** Only specified sub series inserts should be used with equivalent or smaller sub series holders.



A Series Insert +  
A Series Holder



C Series Insert +  
A Series Holder



C Series Insert +  
C Series Holder



A Series Insert +  
C Series Holder

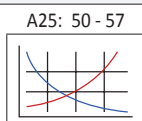
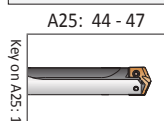

Sizes not shown are available upon request.

When ordering, please follow the example below:

<b>Metric:</b>	13.16 mm, steel, 0 series = use Part No. <b>TAP0-13.16</b>
<b>Imperial:</b>	0.5180", steel, 0 series = use Part No. <b>TAP0-13.16</b>

### T-A Pro Drill Inserts

3 Series | Diameter Range: 35.05 mm - 47.80 mm (1.3798" - 1.8820")

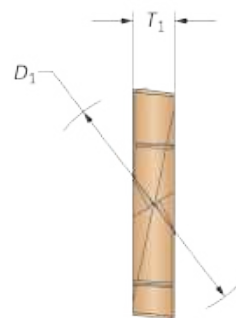
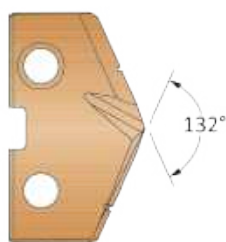

Insert					Carbide				HSS
Series	D <sub>1</sub> mm	D <sub>1</sub> inch	Fractional Equivalent	T <sub>1</sub>					
					Part No.	Part No.	Part No.	Part No.	Part No.
					P	K	N	M	X
3-D	44.40	1.7480	—	1/4	TAP3-44.40	TAK3-44.40	TAN3-44.40	TAM3-44.40	TAX3-44.40
3-D	44.45	1.7500	1-3/4	1/4	TAP3-44.45	TAK3-44.45	TAN3-44.45	TAM3-44.45	TAX3-44.45
3-D	44.50	1.7520	—	1/4	TAP3-44.50	TAK3-44.50	TAN3-44.50	TAM3-44.50	TAX3-44.50
3-D	44.60	1.7559	—	1/4	TAP3-44.60	TAK3-44.60	TAN3-44.60	TAM3-44.60	TAX3-44.60
3-D	44.70	1.7598	—	1/4	TAP3-44.70	TAK3-44.70	TAN3-44.70	TAM3-44.70	TAX3-44.70
3-D	44.80	1.7638	—	1/4	TAP3-44.80	TAK3-44.80	TAN3-44.80	TAM3-44.80	TAX3-44.80
3-D	44.90	1.7677	—	1/4	TAP3-44.90	TAK3-44.90	TAN3-44.90	TAM3-44.90	TAX3-44.90
3-D	45.00	1.7717	—	1/4	TAP3-45.00	TAK3-45.00	TAN3-45.00	TAM3-45.00	TAX3-45.00
3-D	45.10	1.7756	—	1/4	TAP3-45.10	TAK3-45.10	TAN3-45.10	TAM3-45.10	TAX3-45.10
3-D	45.20	1.7795	—	1/4	TAP3-45.20	TAK3-45.20	TAN3-45.20	TAM3-45.20	TAX3-45.20
3-D	45.24	1.7811	1-25/32	1/4	TAP3-45.24	TAK3-45.24	TAN3-45.24	TAM3-45.24	TAX3-45.24
3-D	45.30	1.7835	—	1/4	TAP3-45.30	TAK3-45.30	TAN3-45.30	TAM3-45.30	TAX3-45.30
3-D	45.40	1.7874	—	1/4	TAP3-45.40	TAK3-45.40	TAN3-45.40	TAM3-45.40	TAX3-45.40
3-D	45.50	1.7913	—	1/4	TAP3-45.50	TAK3-45.50	TAN3-45.50	TAM3-45.50	TAX3-45.50
3-D	45.60	1.7953	—	1/4	TAP3-45.60	TAK3-45.60	TAN3-45.60	TAM3-45.60	TAX3-45.60
3-D	45.64	1.7969	1-51/64	1/4	TAP3-45.64	TAK3-45.64	TAN3-45.64	TAM3-45.64	TAX3-45.64
3-D	45.70	1.7992	—	1/4	TAP3-45.70	TAK3-45.70	TAN3-45.70	TAM3-45.70	TAX3-45.70
3-D	45.80	1.8031	—	1/4	TAP3-45.80	TAK3-45.80	TAN3-45.80	TAM3-45.80	TAX3-45.80
3-D	45.90	1.8071	—	1/4	TAP3-45.90	TAK3-45.90	TAN3-45.90	TAM3-45.90	TAX3-45.90
3-D	46.00	1.8110	—	1/4	TAP3-46.00	TAK3-46.00	TAN3-46.00	TAM3-46.00	TAX3-46.00
3-D	46.04	1.8126	1-13/16	1/4	TAP3-46.04	TAK3-46.04	TAN3-46.04	TAM3-46.04	TAX3-46.04
3-D	46.10	1.8150	—	1/4	TAP3-46.10	TAK3-46.10	TAN3-46.10	TAM3-46.10	TAX3-46.10
3-D	46.20	1.8189	—	1/4	TAP3-46.20	TAK3-46.20	TAN3-46.20	TAM3-46.20	TAX3-46.20
3-D	46.30	1.8228	—	1/4	TAP3-46.30	TAK3-46.30	TAN3-46.30	TAM3-46.30	TAX3-46.30
3-D	46.40	1.8268	—	1/4	TAP3-46.40	TAK3-46.40	TAN3-46.40	TAM3-46.40	TAX3-46.40
3-D	46.50	1.8307	—	1/4	TAP3-46.50	TAK3-46.50	TAN3-46.50	TAM3-46.50	TAX3-46.50
3-D	46.60	1.8346	—	1/4	TAP3-46.60	TAK3-46.60	TAN3-46.60	TAM3-46.60	TAX3-46.60
3-D	46.70	1.8386	—	1/4	TAP3-46.70	TAK3-46.70	TAN3-46.70	TAM3-46.70	TAX3-46.70
3-D	46.80	1.8425	—	1/4	TAP3-46.80	TAK3-46.80	TAN3-46.80	TAM3-46.80	TAX3-46.80
3-D	46.83	1.8437	1-27/32	1/4	TAP3-46.83	TAK3-46.83	TAN3-46.83	TAM3-46.83	TAX3-46.83
3-D	46.90	1.8465	—	1/4	TAP3-46.90	TAK3-46.90	TAN3-46.90	TAM3-46.90	TAX3-46.90
3-D	47.00	1.8504	—	1/4	TAP3-47.00	TAK3-47.00	TAN3-47.00	TAM3-47.00	TAX3-47.00
3-D	47.10	1.8543	—	1/4	TAP3-47.10	TAK3-47.10	TAN3-47.10	TAM3-47.10	TAX3-47.10
3-D	47.20	1.8583	—	1/4	TAP3-47.20	TAK3-47.20	TAN3-47.20	TAM3-47.20	TAX3-47.20
3-D	47.30	1.8622	—	1/4	TAP3-47.30	TAK3-47.30	TAN3-47.30	TAM3-47.30	TAX3-47.30
3-D	47.40	1.8661	—	1/4	TAP3-47.40	TAK3-47.40	TAN3-47.40	TAM3-47.40	TAX3-47.40
3-D	47.50	1.8701	—	1/4	TAP3-47.50	TAK3-47.50	TAN3-47.50	TAM3-47.50	TAX3-47.50
3-D	47.60	1.8740	—	1/4	TAP3-47.60	TAK3-47.60	TAN3-47.60	TAM3-47.60	TAX3-47.60
3-D	47.63	1.8752	1-7/8	1/4	TAP3-47.63	TAK3-47.63	TAN3-47.63	TAM3-47.63	TAX3-47.63

Inserts sold in multiples of 1.

#### Sub Series Holders (A, B, C, D)

Sub series holders are recommended when running carbide inserts toward the upper end of the series drill range, as well as in tougher applications requiring more insert support and holder strength. **NOTE:** Only specified sub series inserts should be used with equivalent or smaller sub series holders.



A Series Insert + A Series Holder



C Series Insert + A Series Holder



C Series Insert + C Series Holder



A Series Insert + C Series Holder

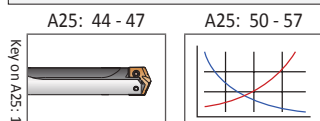

Sizes not shown are available upon request.	
When ordering, please follow the example below:	
<b>Metric:</b>	13.16 mm, steel, 0 series = use Part No. <b>TAP0-13.16</b>
<b>Imperial:</b>	0.5180", steel, 0 series = use Part No. <b>TAP0-13.16</b>

A DRILLING  
B BORING  
C REAMING  
D BURNISHING  
E THREADING  
X SPECIALS

## T-A Pro Drill Holders

3 Series Metric | Diameter Range: 35.05 mm - 47.80 mm

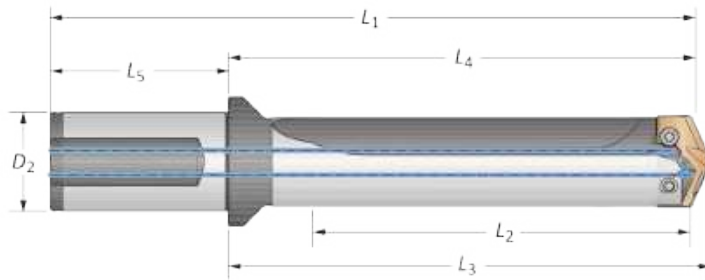

		Body				Shank				
Length	Sub Series	L <sub>2</sub>	L <sub>4</sub>	L <sub>3</sub>	L <sub>1</sub>	L <sub>5</sub>	D <sub>2</sub>	Flat	Part No.	
Stub	A	41.1	92.3	97.1	162.3	70.0	40	Yes	HTA3A01-40FM	
Stub	A	41.1	92.3	97.1	162.3	70.0	40	No	HTA3A01-40CM	
Stub	B	41.1	92.3	97.1	162.3	70.0	40	Yes	HTA3B01-40FM	
Stub	B	41.1	92.3	97.1	162.3	70.0	40	No	HTA3B01-40CM	
Stub	C	41.1	92.3	97.1	162.3	70.0	40	Yes	HTA3C01-40FM	
Stub	C	41.1	92.3	97.1	162.3	70.0	40	No	HTA3C01-40CM	
Stub	D	41.1	92.3	97.1	162.3	70.0	40	Yes	HTA3D01-40FM	
Stub	D	41.1	92.3	97.1	162.3	70.0	40	No	HTA3D01-40CM	
3xD	A	123.3	180.1	184.8	250.1	70.0	40	Yes	HTA3A03-40FM	
3xD	A	123.3	180.1	184.8	250.1	70.0	40	No	HTA3A03-40CM	
3xD	B	123.3	180.1	184.8	250.1	70.0	40	Yes	HTA3B03-40FM	
3xD	B	123.3	180.1	184.8	250.1	70.0	40	No	HTA3B03-40CM	
3xD	C	123.3	180.1	184.8	250.1	70.0	40	Yes	HTA3C03-40FM	
3xD	C	123.3	180.1	184.8	250.1	70.0	40	No	HTA3C03-40CM	
3xD	D	123.3	180.1	184.8	250.1	70.0	40	Yes	HTA3D03-40FM	
3xD	D	123.3	180.1	184.8	250.1	70.0	40	No	HTA3D03-40CM	
5xD	A	205.5	262.3	267.0	332.3	70.0	40	Yes	HTA3A05-40FM	
5xD	A	205.5	262.3	267.0	332.3	70.0	40	No	HTA3A05-40CM	
5xD	B	205.5	262.3	267.0	332.3	70.0	40	Yes	HTA3B05-40FM	
5xD	B	205.5	262.3	267.0	332.3	70.0	40	No	HTA3B05-40CM	
5xD	C	205.5	262.3	267.0	332.3	70.0	40	Yes	HTA3C05-40FM	
5xD	C	205.5	262.3	267.0	332.3	70.0	40	No	HTA3C05-40CM	
5xD	D	205.5	262.3	267.0	332.3	70.0	40	Yes	HTA3D05-40FM	
5xD	D	205.5	262.3	267.0	332.3	70.0	40	No	HTA3D05-40CM	
7xD	A	287.7	344.4	349.2	414.5	70.0	40	Yes	HTA3A07-40FM	
7xD	A	287.7	344.4	349.2	414.5	70.0	40	No	HTA3A07-40CM	
7xD	B	287.7	344.4	349.2	414.5	70.0	40	Yes	HTA3B07-40FM	
7xD	B	287.7	344.4	349.2	414.5	70.0	40	No	HTA3B07-40CM	
7xD	C	287.7	344.4	349.2	414.5	70.0	40	Yes	HTA3C07-40FM	
7xD	C	287.7	344.4	349.2	414.5	70.0	40	No	HTA3C07-40CM	
7xD	D	287.7	344.4	349.2	414.5	70.0	40	Yes	HTA3D07-40FM	
7xD	D	287.7	344.4	349.2	414.5	70.0	40	No	HTA3D07-40CM	

Sub Series	3 Series Holder Diameter Range	
	Metric (mm)	Imperial (inch)
3A	35.05 mm - 47.80 mm	1.3798" - 1.8820"
3B	37.80 mm - 47.80 mm	1.4880" - 1.8820"
3C	41.00 mm - 47.80 mm	1.6140" - 1.8820"
3D	44.40 mm - 47.80 mm	1.7479" - 1.8820"

### Connection Accessories

Insert Screws	Nylon Locking Screws	Insert Driver	Admissible Tightening Torque*
7514-IP20-1	7514N-IP20-1	8IP-20	1370 N-cm (121.3 in-lbs)

\*Tightening torques are calculated with a friction coefficient of  $\mu = 0.14$  and develop 90% of ultimate yield strength.

**1. WARNING** Refer to Speed and Feed charts for recommended adjustments to speeds and feeds. Refer to page **A25: 60** for deep hole drilling guidelines in this section of the catalogue. Visit [www.alliedmachine.com/DeepHoleGuidelines](http://www.alliedmachine.com/DeepHoleGuidelines) for the most up-to-date information and procedures. Factory technical assistance is available for your specific applications through our Application Engineering department.  
email: [engineering.eu@alliedmachine.com](mailto:engineering.eu@alliedmachine.com)

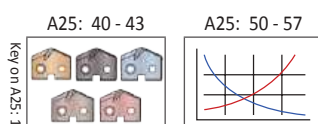

Ⓜ = Metric (mm)  
Ⓜ = Imperial (in)

Screws sold in multiples of 10.





T-A Pro Drill Holders

3 Series Metric | Diameter Range: 35.05 mm - 47.80 mm

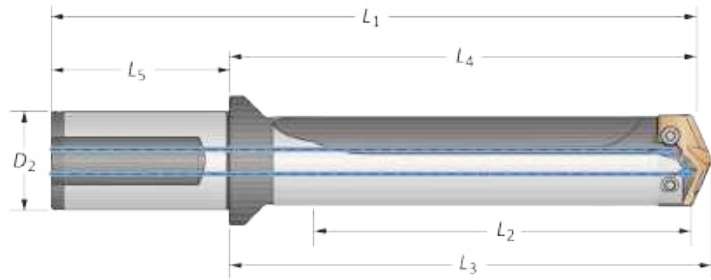

Length	Sub Series	Body				Shank			Flat	Part No.
		L <sub>2</sub>	L <sub>4</sub>	L <sub>3</sub>	L <sub>1</sub>	L <sub>5</sub>	D <sub>2</sub>			
10xD	A	411.0	467.7	472.5	537.7	70.0	40	Yes	HTA3A10-40FM	
10xD	A	411.0	467.7	472.5	537.7	70.0	40	No	HTA3A10-40CM	
10xD	B	411.0	467.7	472.5	537.7	70.0	40	Yes	HTA3B10-40FM	
10xD	B	411.0	467.7	472.5	537.7	70.0	40	No	HTA3B10-40CM	
10xD	C	411.0	467.7	472.5	537.7	70.0	40	Yes	HTA3C10-40FM	
10xD	C	411.0	467.7	472.5	537.7	70.0	40	No	HTA3C10-40CM	
10xD	D	411.0	467.7	472.5	537.7	70.0	40	Yes	HTA3D10-40FM	
10xD	D	411.0	467.7	472.5	537.7	70.0	40	No	HTA3D10-40CM	
12xD	A	493.2	549.9	554.7	619.9	70.0	40	Yes	HTA3A12-40FM	
12xD	A	493.2	549.9	554.7	619.9	70.0	40	No	HTA3A12-40CM	
12xD	B	493.2	549.9	554.7	619.9	70.0	40	Yes	HTA3B12-40FM	
12xD	B	493.2	549.9	554.7	619.9	70.0	40	No	HTA3B12-40CM	
12xD	C	493.2	549.9	554.7	619.9	70.0	40	Yes	HTA3C12-40FM	
12xD	C	493.2	549.9	554.7	619.9	70.0	40	No	HTA3C12-40CM	
12xD	D	493.2	549.9	554.7	619.9	70.0	40	Yes	HTA3D12-40FM	
12xD	D	493.2	549.9	554.7	619.9	70.0	40	No	HTA3D12-40CM	
15xD	A	616.5	673.2	678.0	743.2	70.0	40	Yes	HTA3A15-40FM	
15xD	A	616.5	673.2	678.0	743.2	70.0	40	No	HTA3A15-40CM	
15xD	B	616.5	673.2	678.0	743.2	70.0	40	Yes	HTA3B15-40FM	
15xD	B	616.5	673.2	678.0	743.2	70.0	40	No	HTA3B15-40CM	
15xD	C	616.5	673.2	678.0	743.2	70.0	40	Yes	HTA3C15-40FM	
15xD	C	616.5	673.2	678.0	743.2	70.0	40	No	HTA3C15-40CM	
15xD	D	616.5	673.2	678.0	743.2	70.0	40	Yes	HTA3D15-40FM	
15xD	D	616.5	673.2	678.0	743.2	70.0	40	No	HTA3D15-40CM	

Ⓜ

A

DRILLING

B

BORING

C

REAMING

D

BURNISHING

F

THREADING

X

SPECIALS

Connection Accessories

Sub Series	3 Series Holder Diameter Range	
	Metric (mm)	Imperial (inch)
3A	35.05 mm - 47.80 mm	1.3798" - 1.8820"
3B	37.80 mm - 47.80 mm	1.4880" - 1.8820"
3C	41.00 mm - 47.80 mm	1.6140" - 1.8820"
3D	44.40 mm - 47.80 mm	1.7479" - 1.8820"

Insert Screws	Nylon Locking Screws	Insert Driver	Admissible Tightening Torque*
7514-IP20-1	7514N-IP20-1	8IP-20	1370 N-cm (121.3 in-lbs)

\*Tightening torques are calculated with a friction coefficient of  $\mu = 0.14$  and develop 90% of ultimate yield strength.

**⚠ WARNING** Refer to Speed and Feed charts for recommended adjustments to speeds and feeds. Refer to page A25: 60 for deep hole drilling guidelines in this section of the catalogue. Visit [www.alliedmachine.com/DeepHoleGuidelines](http://www.alliedmachine.com/DeepHoleGuidelines) for the most up-to-date information and procedures. Factory technical assistance is available for your specific applications through our Application Engineering department.  
email: [engineering.eu@alliedmachine.com](mailto:engineering.eu@alliedmachine.com)

A25: 40 - 43      A25: 50 - 57

Ⓜ = Metric (mm)  
 Ⓜ = Imperial (in)  
 Screws sold in multiples of 10.

## T-A Pro Drill Holders

3 Series Imperial | Diameter Range: 1.3798" - 1.8820"

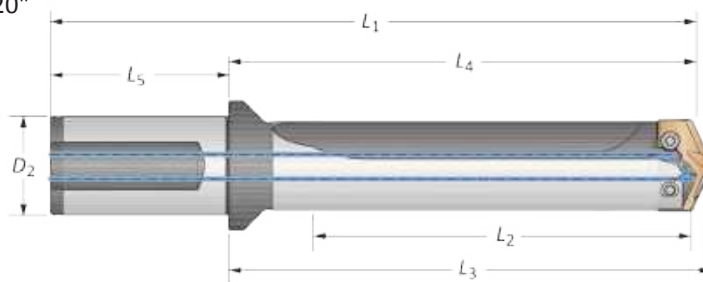

Body						Shank			Flat	Part No.
Length	Sub Series	L <sub>2</sub>	L <sub>4</sub>	L <sub>3</sub>	L <sub>1</sub>	L <sub>5</sub>	D <sub>2</sub>			
Stub	A	1.618	3.634	3.821	6.322	2.688	1-1/2	Yes	HTA3A01-150F	
Stub	A	1.618	3.634	3.821	6.322	2.688	1-1/2	No	HTA3A01-150C	
Stub	B	1.618	3.634	3.821	6.322	2.688	1-1/2	Yes	HTA3B01-150F	
Stub	B	1.618	3.634	3.821	6.322	2.688	1-1/2	No	HTA3B01-150C	
Stub	C	1.618	3.634	3.821	6.322	2.688	1-1/2	Yes	HTA3C01-150F	
Stub	C	1.618	3.634	3.821	6.322	2.688	1-1/2	No	HTA3C01-150C	
Stub	D	1.618	3.634	3.821	6.322	2.688	1-1/2	Yes	HTA3D01-150F	
Stub	D	1.618	3.634	3.821	6.322	2.688	1-1/2	No	HTA3D01-150C	
3xD	A	4.854	7.089	7.276	9.777	2.688	1-1/2	Yes	HTA3A03-150F	
3xD	A	4.854	7.089	7.276	9.777	2.688	1-1/2	No	HTA3A03-150C	
3xD	B	4.854	7.089	7.276	9.777	2.688	1-1/2	Yes	HTA3B03-150F	
3xD	B	4.854	7.089	7.276	9.777	2.688	1-1/2	No	HTA3B03-150C	
3xD	C	4.854	7.089	7.276	9.777	2.688	1-1/2	Yes	HTA3C03-150F	
3xD	C	4.854	7.089	7.276	9.777	2.688	1-1/2	No	HTA3C03-150C	
3xD	D	4.854	7.089	7.276	9.777	2.688	1-1/2	Yes	HTA3D03-150F	
3xD	D	4.854	7.089	7.276	9.777	2.688	1-1/2	No	HTA3D03-150C	
5xD	A	8.090	10.325	10.512	13.013	2.688	1-1/2	Yes	HTA3A05-150F	
5xD	A	8.090	10.325	10.512	13.013	2.688	1-1/2	No	HTA3A05-150C	
5xD	B	8.090	10.325	10.512	13.013	2.688	1-1/2	Yes	HTA3B05-150F	
5xD	B	8.090	10.325	10.512	13.013	2.688	1-1/2	No	HTA3B05-150C	
5xD	C	8.090	10.325	10.512	13.013	2.688	1-1/2	Yes	HTA3C05-150F	
5xD	C	8.090	10.325	10.512	13.013	2.688	1-1/2	No	HTA3C05-150C	
5xD	D	8.090	10.325	10.512	13.013	2.688	1-1/2	Yes	HTA3D05-150F	
5xD	D	8.090	10.325	10.512	13.013	2.688	1-1/2	No	HTA3D05-150C	
7xD	A	11.326	13.561	13.748	16.249	2.688	1-1/2	Yes	HTA3A07-150F	
7xD	A	11.326	13.561	13.748	16.249	2.688	1-1/2	No	HTA3A07-150C	
7xD	B	11.326	13.561	13.748	16.249	2.688	1-1/2	Yes	HTA3B07-150F	
7xD	B	11.326	13.561	13.748	16.249	2.688	1-1/2	No	HTA3B07-150C	
7xD	C	11.326	13.561	13.748	16.249	2.688	1-1/2	Yes	HTA3C07-150F	
7xD	C	11.326	13.561	13.748	16.249	2.688	1-1/2	No	HTA3C07-150C	
7xD	D	11.326	13.561	13.748	16.249	2.688	1-1/2	Yes	HTA3D07-150F	
7xD	D	11.326	13.561	13.748	16.249	2.688	1-1/2	No	HTA3D07-150C	

Sub Series	3 Series Holder Diameter Range	
	Metric (mm)	Imperial (inch)
3A	35.05 mm - 47.80 mm	1.3798" - 1.8820"
3B	37.80 mm - 47.80 mm	1.4880" - 1.8820"
3C	41.00 mm - 47.80 mm	1.6140" - 1.8820"
3D	44.40 mm - 47.80 mm	1.7479" - 1.8820"

### Connection Accessories

Insert Screws	Nylon Locking Screws	Insert Driver	Admissible Tightening Torque*
7514-IP20-1	7514N-IP20-1	8IP-20	1370 N-cm (121.3 in-lbs)

\*Tightening torques are calculated with a friction coefficient of  $\mu = 0.14$  and develop 90% of ultimate yield strength.

**1. WARNING** Refer to Speed and Feed charts for recommended adjustments to speeds and feeds. Refer to page A25: 60 for deep hole drilling guidelines in this section of the catalogue. Visit [www.alliedmachine.com/DeepHoleGuidelines](http://www.alliedmachine.com/DeepHoleGuidelines) for the most up-to-date information and procedures. Factory technical assistance is available for your specific applications through our Application Engineering department.  
email: [engineering.eu@alliedmachine.com](mailto:engineering.eu@alliedmachine.com)

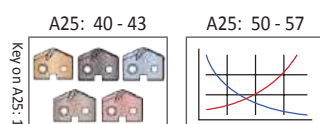

= Metric (mm)  
 = Imperial (in)

Screws sold in multiples of 10.



T-A Pro Drill Holders

3 Series Imperial | Diameter Range: 1.3798" - 1.8820"

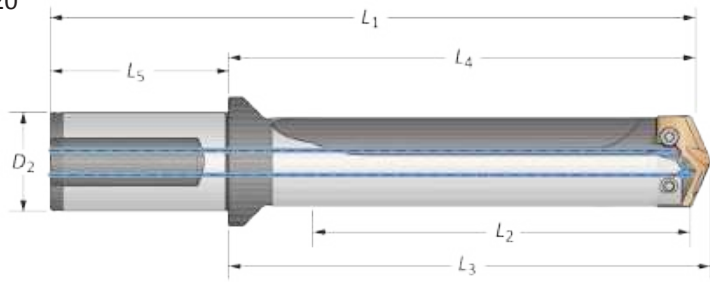

Length	Sub Series	Body				Shank			Flat	Part No.
		L <sub>2</sub>	L <sub>4</sub>	L <sub>3</sub>	L <sub>1</sub>	L <sub>5</sub>	D <sub>2</sub>			
10xD	A	16.180	18.415	18.602	21.103	2.688	1-1/2	Yes	HTA3A10-150F	
10xD	A	16.180	18.415	18.602	21.103	2.688	1-1/2	No	HTA3A10-150C	
10xD	B	16.180	18.415	18.602	21.103	2.688	1-1/2	Yes	HTA3B10-150F	
10xD	B	16.180	18.415	18.602	21.103	2.688	1-1/2	No	HTA3B10-150C	
10xD	C	16.180	18.415	18.602	21.103	2.688	1-1/2	Yes	HTA3C10-150F	
10xD	C	16.180	18.415	18.602	21.103	2.688	1-1/2	No	HTA3C10-150C	
10xD	D	16.180	18.415	18.602	21.103	2.688	1-1/2	Yes	HTA3D10-150F	
10xD	D	16.180	18.415	18.602	21.103	2.688	1-1/2	No	HTA3D10-150C	
12xD	A	19.416	21.651	21.838	24.339	2.688	1-1/2	Yes	HTA3A12-150F	
12xD	A	19.416	21.651	21.838	24.339	2.688	1-1/2	No	HTA3A12-150C	
12xD	B	19.416	21.651	21.838	24.339	2.688	1-1/2	Yes	HTA3B12-150F	
12xD	B	19.416	21.651	21.838	24.339	2.688	1-1/2	No	HTA3B12-150C	
12xD	C	19.416	21.651	21.838	24.339	2.688	1-1/2	Yes	HTA3C12-150F	
12xD	C	19.416	21.651	21.838	24.339	2.688	1-1/2	No	HTA3C12-150C	
12xD	D	19.416	21.651	21.838	24.339	2.688	1-1/2	Yes	HTA3D12-150F	
12xD	D	19.416	21.651	21.838	24.339	2.688	1-1/2	No	HTA3D12-150C	
15xD	A	24.270	26.505	26.692	29.193	2.688	1-1/2	Yes	HTA3A15-150F	
15xD	A	24.270	26.505	26.692	29.193	2.688	1-1/2	No	HTA3A15-150C	
15xD	B	24.270	26.505	26.692	29.193	2.688	1-1/2	Yes	HTA3B15-150F	
15xD	B	24.270	26.505	26.692	29.193	2.688	1-1/2	No	HTA3B15-150C	
15xD	C	24.270	26.505	26.692	29.193	2.688	1-1/2	Yes	HTA3C15-150F	
15xD	C	24.270	26.505	26.692	29.193	2.688	1-1/2	No	HTA3C15-150C	
15xD	D	24.270	26.505	26.692	29.193	2.688	1-1/2	Yes	HTA3D15-150F	
15xD	D	24.270	26.505	26.692	29.193	2.688	1-1/2	No	HTA3D15-150C	

1

A DRILLING  
B BORING  
C REAMING  
D BURNISHING  
E THREADING  
F SPECIALS

Sub Series	3 Series Holder Diameter Range	
	Metric (mm)	Imperial (inch)
3A	35.05 mm - 47.80 mm	1.3798" - 1.8820"
3B	37.80 mm - 47.80 mm	1.4880" - 1.8820"
3C	41.00 mm - 47.80 mm	1.6140" - 1.8820"
3D	44.40 mm - 47.80 mm	1.7479" - 1.8820"

Connection Accessories

Insert Screws	Nylon Locking Screws	Insert Driver	Admissible Tightening Torque*
7514-IP20-1	7514N-IP20-1	8IP-20	1370 N-cm (121.3 in-lbs)

\*Tightening torques are calculated with a friction coefficient of  $\mu = 0.14$  and develop 90% of ultimate yield strength.

**1. WARNING** Refer to Speed and Feed charts for recommended adjustments to speeds and feeds. Refer to page A25: 60 for deep hole drilling guidelines in this section of the catalogue. Visit [www.alliedmachine.com/DeepHoleGuidelines](http://www.alliedmachine.com/DeepHoleGuidelines) for the most up-to-date information and procedures. Factory technical assistance is available for your specific applications through our Application Engineering department.  
email: [engineering.eu@alliedmachine.com](mailto:engineering.eu@alliedmachine.com)

A25: 40 - 43 A25: 50 - 57

Ⓜ = Metric (mm)  
Ⓢ = Imperial (in)  
Screws sold in multiples of 10.

## T-A Pro Kits

12.70 mm - 35.04 mm (0.4999" - 1.3797") | Holders



### Metric 3xD Holder Kits

	Series	Length	Drill Depth	Shank Diameter	Qty
m	0-A	3xD	45.9	20	1
	1-A	3xD	62.9	25	1
	2-A	3xD	89.2	32	1

HTA03FM-KIT

Flanged with flat
HTA0A03-20FM
HTA1A03-25FM
HTA2A03-32FM

HTA03CM-KIT

Cylindrical (no flat)
HTA0A03-20CM
HTA1A03-25CM
HTA2A03-32CM

### Metric 5xD Holder Kits

	Series	Length	Drill Depth	Shank Diameter	Qty
m	0-A	5xD	76.6	20	1
	1-A	5xD	104.8	25	1
	2-A	5xD	148.7	32	1

HTA05FM-KIT

Flanged with flat
HTA0A05-20FM
HTA1A05-25FM
HTA2A05-32FM

HTA05CM-KIT

Cylindrical (no flat)
HTA0A05-20CM
HTA1A05-25CM
HTA2A05-32CM

### Imperial 3xD Holder Kits

	Series	Length	Drill Depth	Shank Diameter	Qty
i	0-A	3xD	1.809	0.750	1
	1-A	3xD	2.475	1.000	1
	2-A	3xD	3.513	1.250	1

HTA03F-KIT

Flanged with flat
HTA0A03-075F
HTA1A03-100F
HTA2A03-125F

HTA03C-KIT

Cylindrical (no flat)
HTA0A03-075C
HTA1A03-100C
HTA2A03-125C

### Imperial 5xD Holder Kits

	Series	Length	Drill Depth	Shank Diameter	Qty
i	0-A	5xD	3.015	0.750	1
	1-A	5xD	4.125	1.000	1
	2-A	5xD	5.855	1.250	1

HTA05F-KIT

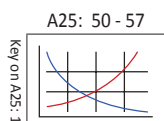
Flanged with flat
HTA0A05-075F
HTA1A05-100F
HTA2A05-125F

HTA05C-KIT

Cylindrical (no flat)
HTA0A05-075C
HTA1A05-100C
HTA2A05-125C



m = Metric (mm)  
i = Imperial (in)

A DRILLING  
B BORING  
C REAMING  
D BURNISHING  
E THREADING  
X SPECIALS



**T-A Pro Kits**

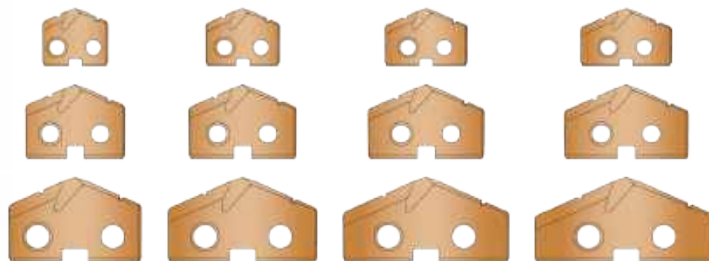

12.70 mm - 35.04 mm (0.4999" - 1.3797") | Inserts







**Metric Insert Kit**



Series	Diameter			Qty
	mm	inch	Fractional	
0-A	13.00	0.5118	—	2
0-B	14.00	0.5512	—	2
0-C	16.00	0.6299	—	2
0-D	17.50	0.6890	—	2
1-A	18.00	0.7087	—	2
1-B	20.00	0.7874	—	2
1-C	22.00	0.8661	—	2
1-D	24.00	0.9449	—	2
2-A	25.00	0.9843	63/64	2
2-C	30.00	1.1811	—	2
2-D	32.00	1.2598	—	2
2-D	35.00	1.3780	—	2

TAP-MET-KIT
 
TAP0-13.00
TAP0-14.00
TAP0-16.00
TAP0-17.50
TAP1-18.00
TAP1-20.00
TAP1-22.00
TAP1-24.00
TAP2-25.00
TAP2-30.00
TAP2-32.00
TAP2-35.00

TAK-MET-KIT
 
TAK0-13.00
TAK0-14.00
TAK0-16.00
TAK0-17.50
TAK1-18.00
TAK1-20.00
TAK1-22.00
TAK1-24.00
TAK2-25.00
TAK2-30.00
TAK2-32.00
TAK2-35.00



TAN-MET-KIT
 
TAN0-13.00
TAN0-14.00
TAN0-16.00
TAN0-17.50
TAN1-18.00
TAN1-20.00
TAN1-22.00
TAN1-24.00
TAN2-25.00
TAN2-30.00
TAN2-32.00
TAN2-35.00



TAM-MET-KIT
 
TAM0-13.00
TAM0-14.00
TAM0-16.00
TAM0-17.50
TAM1-18.00
TAM1-20.00
TAM1-22.00
TAM1-24.00
TAM2-25.00
TAM2-30.00
TAM2-32.00
TAM2-35.00



TAX-MET-KIT
 
TAX0-13.00
TAX0-14.00
TAX0-16.00
TAX0-17.50
TAX1-18.00
TAX1-20.00
TAX1-22.00
TAX1-24.00
TAX2-25.00
TAX2-30.00
TAX2-32.00
TAX2-35.00



**Imperial Insert Kit**



Series	Diameter			Qty
	mm	inch	Fractional	
0-A	12.70	0.5000	1/2	2
0-B	14.29	0.5626	9/16	2
0-C	15.88	0.6252	5/8	2
0-D	17.46	0.6874	11/16	2
1-B	19.05	0.7500	3/4	2
1-C	20.64	0.8126	13/16	2
1-C	22.23	0.8752	7/8	2
1-D	23.81	0.9374	15/16	2
2-B	25.40	1.0000	1	2
2-C	28.58	1.1252	1-1/8	2
2-D	31.75	1.2500	1-1/4	2
2-D	34.93	1.3752	1-3/8	2

TAP-IMP-KIT
 
TAP0-12.70
TAP0-14.29
TAP0-15.88
TAP0-17.46
TAP1-19.05
TAP1-20.64
TAP1-22.23
TAP1-23.81
TAP2-25.40
TAP2-28.58
TAP2-31.75
TAP2-34.93

TAK-IMP-KIT
 
TAK0-12.70
TAK0-14.29
TAK0-15.88
TAK0-17.46
TAK1-19.05
TAK1-20.64
TAK1-22.23
TAK1-23.81
TAK2-25.40
TAK2-28.58
TAK2-31.75
TAK2-34.93

TAN-IMP-KIT
 
TAN0-12.70
TAN0-14.29
TAN0-15.88
TAN0-17.46
TAN1-19.05
TAN1-20.64
TAN1-22.23
TAN1-23.81
TAN2-25.40
TAN2-28.58
TAN2-31.75
TAN2-34.93

TAM-IMP-KIT
 
TAM0-12.70
TAM0-14.29
TAM0-15.88
TAM0-17.46
TAM1-19.05
TAM1-20.64
TAM1-22.23
TAM1-23.81
TAM2-25.40
TAM2-28.58
TAM2-31.75
TAM2-34.93

TAX-IMP-KIT
 
TAX0-12.70
TAX0-14.29
TAX0-15.88
TAX0-17.46
TAX1-19.05
TAX1-20.64
TAX1-22.23
TAX1-23.81
TAX2-25.40
TAX2-28.58
TAX2-31.75
TAX2-34.93



**T-A PRO MATERIAL LIBRARY:**  
SEE IT IN ACTION.

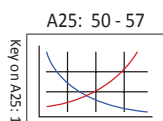

 = Metric (mm)  
 = Imperial (in)

A  
DRILLING  
B  
BORING  
C  
REAMING  
D  
BURISHING  
E  
THREADING  
X  
SPECIALS



## Carbide Recommended Drilling Data | Metric (mm)

ISO	Material	Hardness (BHN)	Insert Grade	Speed (m/min)	Feed Rate (mm/rev) by Diameter				
					Y / Z Series (9.50 - 12.69)	0 Series (12.70 - 17.64)	1 Series (17.65 - 24.37)	2 Series (24.38 - 35.04)	3 Series (35.05 - 47.80)
P	Free-Machining Steel 1118, 1215, 12L14, etc.	100 - 150	P	145	0.18	0.25	0.33	0.41	0.51
		150 - 200	P	135	0.18	0.25	0.33	0.41	0.51
		200 - 250	P	125	0.15	0.25	0.33	0.41	0.51
	Low-Carbon Steel 1010, 1020, 1025, 1522, 1144, etc.	85 - 125	P	130	0.15❖	0.23	0.30	0.38	0.48
		125 - 175	P	125	0.15❖	0.23	0.30	0.38	0.48
		175 - 225	P	115	0.13❖	0.20	0.25	0.36	0.46
		225 - 275	P	110	0.13❖	0.20	0.25	0.36	0.46
	Medium-Carbon Steel 1030, 1040, 1050, 1527, 1140, 1151, etc.	125 - 175	P	125	0.15	0.23	0.30	0.38	0.48
		175 - 225	P	115	0.13	0.20	0.25	0.36	0.46
		225 - 275	P	110	0.13	0.20	0.25	0.36	0.46
		275 - 325	P	100	0.10	0.18	0.23	0.30	0.41
	Alloy Steel 4140, 5140, 8640, etc.	125 - 175	P	130	0.15	0.23	0.30	0.36	0.43
		175 - 225	P	120	0.13	0.20	0.28	0.36	0.43
		225 - 275	P	110	0.13	0.20	0.28	0.36	0.43
		275 - 325	P	105	0.10	0.18	0.25	0.30	0.38
		325 - 375	P	95	0.08	0.18	0.25	0.30	0.38
	High-Strength Alloy 4340, 4330V, 300M, etc.	225 - 300	P	105	0.10	0.18	0.25	0.33	0.38
		300 - 350	P	100	0.08	0.15	0.23	0.30	0.36
		350 - 400	P	90	0.08	0.15	0.20	0.28	0.33
	Structural Steel A36, A285, A516, etc.	100 - 150	P	120	0.15❖	0.25	0.30	0.36	0.46
150 - 250		P	105	0.13❖	0.23	0.25	0.30	0.41	
250 - 350		P	85	0.10❖	0.20	0.23	0.25	0.36	
Tool Steel H-13, H-21, A-4, S-3, etc.	150 - 200	P	65	0.10	0.15	0.20	0.25	0.30	
	200 - 250	P	55	0.10	0.15	0.20	0.25	0.30	
S	High-Temp Alloy Hastelloy B, Inconel 600, etc.	140 - 220	M	35	0.05❖	0.13	0.18	0.20	0.23
		220 - 310	M	25	0.05❖	0.08	0.13	0.15	0.18
	Titanium Alloy	140 - 220	M	45	0.08❖	0.10	0.18	0.20	0.23
		220 - 310	M	35	0.08❖	0.08	0.13	0.15	0.18
	Aerospace Alloy S82	185 - 275	M	45	0.08❖	0.10	0.18	0.20	0.23
	275 - 350	M	35	0.08❖	0.08	0.13	0.15	0.18	

❖ Contact our Application Engineering department for assistance when machining these materials.

### 7xD and 10xD Adjustment Example (0.80 Adjustment)

Data • Adjustment Value	Speed/Feed (7xD)
100 m/min • 0.80	= 80 m/min
0.2 mm/rev • 0.80	= 0.16 mm/rev

### 12xD and 15xD Adjustment Example (0.70 Adjustment)

Speed • Adjustment Value	Speed/Feed (12xD)
100 m/min • 0.70	= 70 m/min
0.2 mm/rev • 0.70	= 0.14 mm/rev

### Coolant Recommendations

Series	Stub, 3xD, 5xD		7xD, 10xD		12xD, 15xD	
	Pressure BAR	Flow Rate LPM	Pressure BAR	Flow Rate LPM	Pressure BAR	Flow Rate LPM
Y	31	15	34	55	45	30
Z	31	15	34	22	45	30
0	24	22	31	34	34	45
1	21	30	27	38	34	45
2	17	38	24	49	31	60
3	14	45	21	53	27	68

#### ⚠ WARNING Tool failure can cause serious injury. To prevent:

- When using holders without support bushing, use a short T-A Pro holder to establish an initial hole that is a minimum of 2 diameters deep.
- Do not rotate tool holders more than 50 RPM unless it is engaged with the workpiece or fixture.

Visit [www.alliedmachine.com/DeepHoleGuidelines](http://www.alliedmachine.com/DeepHoleGuidelines) for the most up-to-date information and procedures.

Factory technical assistance is available for your specific applications through our Application Engineering department. *email: [engineering.eu@alliedmachine.com](mailto:engineering.eu@alliedmachine.com)*

**IMPORTANT:** The speeds and feeds listed above are a general starting point for all applications. Refer to the coolant recommendation chart for coolant requirements to run at the recommended speeds and feeds. Factory technical assistance is available through our Application Engineering department. For 7xD, 10xD, 12xD and 15xD holder lengths, see adjustment example above.

**Carbide Recommended Drilling Data | Metric (mm)**

ISO	Material	Hardness (BHN)	Insert Grade	Speed (m/min)	Feed Rate (mm/rev) by Diameter				
					Y / Z Series (9.50 - 12.69)	0 Series (12.70 - 17.64)	1 Series (17.65 - 24.37)	2 Series (24.38 - 35.04)	3 Series (35.05 - 47.80)
M	Stainless Steel 400 Series 416, 420, etc.	185 - 275	M	85	0.13❖	0.23	0.25	0.30	0.33
		275 - 350	M	70	0.10❖	0.20	0.23	0.28	0.30
	Stainless Steel 300 Series 304, 316, 17-4PH, etc.	135 - 185	M	85	0.08❖	0.10	0.13	0.20	0.28
		185 - 275	M	75	0.05❖	0.08	0.10	0.18	0.23
	Stainless Steel 300L Series 304L, 316L, etc.	135 - 185	M	100	0.08❖	0.10	0.13	0.20	0.28
		185 - 275	M	85	0.05❖	0.08	0.10	0.18	0.23
	PH Stainless 17-4, 13-8, 15-5	275 - 350	M	85	0.08❖	0.10	0.13	0.20	0.28
		350 - 425	M	75	0.05❖	0.08	0.10	0.18	0.23
Super Duplex Stainless Steel	135 - 185	M	75	0.08❖	0.10	0.13	0.20	0.28	
	185 - 275	M	70	0.05❖	0.08	0.10	0.18	0.23	
H	Wear Plate Hardox®, AR400, T-1, etc.	400	P	20	0.08	0.15	0.20	0.23	0.30
		500	P	15	0.05	0.13	0.18	0.20	0.25
		600	-	-	-	-	-	-	-
	Hardened Steel	300 - 400	P	30	0.08	0.15	0.20	0.23	0.30
400 - 500		P	15	0.05	0.13	0.18	0.20	0.25	
K	SG / Nodular Cast Iron	120 - 150	K	185	0.18	0.30	0.41	0.51	0.61
		150 - 200	K	170	0.15	0.28	0.36	0.46	0.56
		200 - 220	K	150	0.15	0.23	0.30	0.41	0.46
		220 - 260	K	135	0.13	0.18	0.23	0.30	0.36
		260 - 320	K	120	0.10	0.15	0.18	0.23	0.30
N	Cast Aluminium	30	N	335	0.20	0.33	0.41	0.51	0.56
		180	N	185	0.20	0.33	0.41	0.46	0.56
	Wrought Aluminium	30	N	335	0.23	0.33	0.43	0.51	0.61
		180	N	185	0.13	0.18	0.25	0.33	0.41
	Aluminium Bronze	100 - 200	N	150	0.15	0.28	0.36	0.46	0.56
		200 - 250	N	90	0.13	0.18	0.23	0.30	0.36
	Brass	100	N	200	0.18	0.30	0.41	0.51	0.61
Copper	60	N	130	0.05	0.08	0.15	0.20	0.25	

❖ Contact our Application Engineering department for assistance when machining these materials.

**7xD and 10xD Adjustment Example (0.80 Adjustment)**

Data • Adjustment Value	Speed/Feed (7xD)
100 m/min • 0.80	= 80 m/min
0.2 mm/rev • 0.80	= 0.16 mm/rev

**12xD and 15xD Adjustment Example (0.70 Adjustment)**

Speed • Adjustment Value	Speed/Feed (12xD)
100 m/min • 0.70	= 70 m/min
0.2 mm/rev • 0.70	= 0.14 mm/rev

**Coolant Recommendations**

Series	Stub, 3xD, 5xD		7xD, 10xD		12xD, 15xD	
	Pressure BAR	Flow Rate LPM	Pressure BAR	Flow Rate LPM	Pressure BAR	Flow Rate LPM
Y	31	15	34	55	45	30
Z	31	15	34	22	45	30
0	24	22	31	34	34	45
1	21	30	27	38	34	45
2	17	38	24	49	31	60
3	14	45	21	53	27	68

**⚠ WARNING**

Tool failure can cause serious injury. To prevent:

- When using holders without support bushing, use a short T-A Pro holder to establish an initial hole that is a minimum of 2 diameters deep.
- Do not rotate tool holders more than 50 RPM unless it is engaged with the workpiece or fixture.

Visit [www.alliedmachine.com/DeepHoleGuidelines](http://www.alliedmachine.com/DeepHoleGuidelines) for the most up-to-date information and procedures.

Factory technical assistance is available for your specific applications through our Application Engineering department. *email: [engineering.eu@alliedmachine.com](mailto:engineering.eu@alliedmachine.com)*

**IMPORTANT:** The speeds and feeds listed above are a general starting point for all applications. Refer to the coolant recommendation chart for coolant requirements to run at the recommended speeds and feeds. Factory technical assistance is available through our Application Engineering department. For 7xD, 10xD, 12xD and 15xD holder lengths, see adjustment example above.

A  
DRILLING  
B  
BORING  
C  
REAMING  
D  
BURNISHING  
E  
THREADING  
X  
SPECIALS

## High-Speed Steel Recommended Drilling Data | Metric (mm)

ISO	Material	Hardness (BHN)	Insert Grade	Speed (m/min)	Feed Rate (mm/rev) by Diameter				
					Y / Z Series (9.50 - 12.69)	0 Series (12.70 - 17.64)	1 Series (17.65 - 24.37)	2 Series (24.38 - 35.04)	3 Series (35.05 - 47.80)
P	Free-Machining Steel 1118, 1215, 12L14, etc.	100 - 150	X	105	0.15	0.25	0.33	0.41	0.51
		150 - 200	X	100	0.15	0.25	0.33	0.41	0.51
		200 - 250	X	90	0.13	0.25	0.33	0.41	0.51
	Low-Carbon Steel 1010, 1020, 1025, 1522, 1144, etc.	85 - 125	X	95	0.15❖	0.23	0.30	0.38	0.48
		125 - 175	X	90	0.13❖	0.23	0.30	0.38	0.48
		175 - 225	X	85	0.13❖	0.20	0.25	0.36	0.46
	Medium-Carbon Steel 1030, 1040, 1050, 1527, 1140, 1151, etc.	225 - 275	X	80	0.13❖	0.20	0.25	0.36	0.46
		125 - 175	X	90	0.15	0.23	0.30	0.38	0.48
		175 - 225	X	85	0.13	0.20	0.25	0.36	0.46
	Alloy Steel 4140, 5140, 8640, etc.	225 - 275	X	80	0.13	0.20	0.25	0.36	0.46
		275 - 325	X	70	0.10	0.18	0.23	0.30	0.41
		125 - 175	X	75	0.15	0.23	0.30	0.36	0.43
		175 - 225	X	70	0.13	0.20	0.28	0.36	0.43
	High-Strength Alloy 4340, 4330V, 300M, etc.	225 - 275	X	65	0.13	0.20	0.28	0.36	0.43
		275 - 325	X	60	0.10	0.18	0.25	0.30	0.38
		325 - 375	X	60	0.08	0.18	0.25	0.30	0.38
	Structural Steel A36, A285, A516, etc.	225 - 300	X	40	0.10	0.18	0.25	0.33	0.38
		300 - 350	X	35	0.08	0.15	0.23	0.30	0.36
		350 - 400	X	25	0.08	0.15	0.20	0.28	0.33
	Tool Steel H-13, H-21, A-4, S-3, etc.	100 - 150	X	75	0.15❖	0.25	0.30	0.36	0.46
150 - 250		X	65	0.13❖	0.23	0.25	0.30	0.41	
250 - 350		X	55	0.10❖	0.20	0.23	0.25	0.36	
S	High-Temp Alloy Hastelloy B, Inconel 600, etc.	150 - 200	X	45	0.10	0.15	0.20	0.25	0.30
		200 - 250	X	35	0.10	0.15	0.20	0.25	0.30
	Titanium Alloy	140 - 220	X	15	0.08❖	0.18	0.20	0.25	0.30
		220 - 310	X	10	0.08❖	0.15	0.18	0.20	0.25
	Aerospace Alloy S82	140 - 220	X	20	0.08	0.18	0.20	0.25	0.30
		220 - 310	X	15	0.08	0.15	0.18	0.20	0.25
Aerospace Alloy S82	185 - 275	X	40	0.13	0.20	0.23	0.25	0.36	
	275 - 350	X	35	0.10	0.18	0.20	0.20	0.30	

❖ Contact our Application Engineering department for assistance when machining these materials.

### 7xD and 10xD Adjustment Example (0.80 Adjustment)

Data • Adjustment Value	Speed/Feed (7xD)
100 m/min • 0.80	= 80 m/min
0.2 mm/rev • 0.80	= 0.16 mm/rev

### 12xD and 15xD Adjustment Example (0.70 Adjustment)

Speed • Adjustment Value	Speed/Feed (12xD)
100 m/min • 0.70	= 70 m/min
0.2 mm/rev • 0.70	= 0.14 mm/rev

### Coolant Recommendations

Series	Stub, 3xD, 5xD		7xD, 10xD		12xD, 15xD	
	Pressure BAR	Flow Rate LPM	Pressure BAR	Flow Rate LPM	Pressure BAR	Flow Rate LPM
Y	31	15	34	55	45	30
Z	31	15	34	22	45	30
0	24	22	31	34	34	45
1	21	30	27	38	34	45
2	17	38	24	49	31	60
3	14	45	21	53	27	68

#### ⚠ WARNING

Tool failure can cause serious injury. To prevent:

- When using holders without support bushing, use a short T-A Pro holder to establish an initial hole that is a minimum of 2 diameters deep.
- Do not rotate tool holders more than 50 RPM unless it is engaged with the workpiece or fixture.

Visit [www.alliedmachine.com/DeepHoleGuidelines](http://www.alliedmachine.com/DeepHoleGuidelines) for the most up-to-date information and procedures.

Factory technical assistance is available for your specific applications through our Application Engineering department. *email: [engineering.eu@alliedmachine.com](mailto:engineering.eu@alliedmachine.com)*

**IMPORTANT:** The speeds and feeds listed above are a general starting point for all applications. Refer to the coolant recommendation chart for coolant requirements to run at the recommended speeds and feeds. Factory technical assistance is available through our Application Engineering department. For 7xD, 10xD, 12xD and 15xD holder lengths, see adjustment example above.



## High-Speed Steel Recommended Drilling Data | Metric (mm)

ISO	Material	Hardness (BHN)	Insert Grade	Speed (m/min)	Feed Rate (mm/rev) by Diameter				
					Y / Z Series (9.50 - 12.69)	0 Series (12.70 - 17.64)	1 Series (17.65 - 24.37)	2 Series (24.38 - 35.04)	3 Series (35.05 - 47.80)
M	Stainless Steel 400 Series 416, 420, etc.	185 - 275	X	40	0.13❖	0.25	0.28	0.30	0.33
		275 - 350	X	35	0.10❖	0.23	0.25	0.28	0.30
	Stainless Steel 300 Series 304, 316, 17-4PH, etc.	135 - 185	X	40	0.13❖	0.18	0.20	0.23	0.30
		185 - 275	X	35	0.10❖	0.15	0.18	0.20	0.28
	PH Stainless 17-4, 13-8, 15-5	275 - 350	X	30	0.08❖	0.10	0.15	0.20	0.25
		350 - 425	X	25	0.08❖	0.10	0.15	0.20	0.25
Super Duplex Stainless Steel	135 - 185	X	40	0.13❖	0.13	0.15	0.15	0.18	
	185 - 275	X	35	0.10❖	0.13	0.13	0.15	0.15	
H	Wear Plate Hardox®, AR400, T-1, etc.	400	X	20	0.08	0.15	0.20	0.23	0.30
		500	X	15	0.05	0.13	0.18	0.20	0.25
		600	-	-	-	-	-	-	-
	Hardened Steel	300 - 400	X	25	0.08	0.15	0.20	0.23	0.30
400 - 500		X	15	0.05	0.13	0.18	0.20	0.25	
K	SG / Nodular Cast Iron	120 - 150	X	90	0.18	0.30	0.41	0.51	0.61
		150 - 200	X	85	0.15	0.28	0.36	0.46	0.56
		200 - 220	X	75	0.15	0.23	0.30	0.41	0.46
		220 - 260	X	65	0.13	0.18	0.23	0.30	0.36
		260 - 320	X	55	0.10	0.15	0.18	0.23	0.30
N	Cast Aluminium	30	X	185	0.20	0.33	0.41	0.51	0.56
		180	X	90	0.20	0.33	0.41	0.46	0.56
	Wrought Aluminium	30	X	275	0.23	0.33	0.43	0.51	0.61
		180	X	185	0.13	0.18	0.25	0.33	0.41
	Aluminium Bronze	100 - 200	X	90	0.15	0.28	0.36	0.46	0.56
		200 - 250	X	75	0.13	0.18	0.23	0.30	0.36
	Brass	100	X	150	0.18	0.30	0.41	0.51	0.61
Copper	60	X	100	0.05	0.08	0.15	0.20	0.25	

❖ Contact our Application Engineering department for assistance when machining these materials.

### 7xD and 10xD Adjustment Example (0.80 Adjustment)

Data • Adjustment Value	Speed/Feed (7xD)
100 m/min • 0.80	= 80 m/min
0.2 mm/rev • 0.80	= 0.16 mm/rev

### 12xD and 15xD Adjustment Example (0.70 Adjustment)

Speed • Adjustment Value	Speed/Feed (12xD)
100 m/min • 0.70	= 70 m/min
0.2 mm/rev • 0.70	= 0.14 mm/rev

### Coolant Recommendations

Series	Stub, 3xD, 5xD		7xD, 10xD		12xD, 15xD	
	Pressure BAR	Flow Rate LPM	Pressure BAR	Flow Rate LPM	Pressure BAR	Flow Rate LPM
Y	31	15	34	55	45	30
Z	31	15	34	22	45	30
0	24	22	31	34	34	45
1	21	30	27	38	34	45
2	17	38	24	49	31	60
3	14	45	21	53	27	68

#### ⚠ WARNING

Tool failure can cause serious injury. To prevent:

- When using holders without support bushing, use a short T-A Pro holder to establish an initial hole that is a minimum of 2 diameters deep.
- Do not rotate tool holders more than 50 RPM unless it is engaged with the workpiece or fixture.

Visit [www.alliedmachine.com/DeepHoleGuidelines](http://www.alliedmachine.com/DeepHoleGuidelines) for the most up-to-date information and procedures.

Factory technical assistance is available for your specific applications through our Application Engineering department. *email: [engineering.eu@alliedmachine.com](mailto:engineering.eu@alliedmachine.com)*

**IMPORTANT:** The speeds and feeds listed above are a general starting point for all applications. Refer to the coolant recommendation chart for coolant requirements to run at the recommended speeds and feeds. Factory technical assistance is available through our Application Engineering department. For 7xD, 10xD, 12xD and 15xD holder lengths, see adjustment example above.

Carbide Recommended Drilling Data | Imperial (inch)

A DRILLING  
B BORING  
C REAMING  
D BURISHING  
E THREADING  
X SPECIALS

ISO	Material	Hardness (BHN)	Insert Grade	Speed (SFM)	Feed Rate (IPR) by Diameter				
					Y / Z Series (0.3739" - 0.4998")	0 Series (0.4999" - 0.6946")	1 Series (0.6947" - 0.9596")	2 Series (0.9597" - 1.3797")	3 Series (1.3798" - 1.8820")
P	Free-Machining Steel 1118, 1215, 12L14, etc.	100 - 150	P	475	0.007	0.010	0.013	0.016	0.020
		150 - 200	P	440	0.007	0.010	0.013	0.016	0.020
		200 - 250	P	410	0.006	0.010	0.013	0.016	0.020
	Low-Carbon Steel 1010, 1020, 1025, 1522, 1144, etc.	85 - 125	P	425	0.006❖	0.009	0.012	0.015	0.019
		125 - 175	P	410	0.006❖	0.009	0.012	0.015	0.019
		175 - 225	P	385	0.005❖	0.008	0.010	0.014	0.018
		225 - 275	P	355	0.005❖	0.008	0.010	0.014	0.018
	Medium-Carbon Steel 1030, 1040, 1050, 1527, 1140, 1151, etc.	125 - 175	P	410	0.006	0.009	0.012	0.015	0.019
		175 - 225	P	385	0.005	0.008	0.010	0.014	0.018
		225 - 275	P	355	0.005	0.008	0.010	0.014	0.018
		275 - 325	P	330	0.004	0.007	0.009	0.012	0.016
	Alloy Steel 4140, 5140, 8640, etc.	125 - 175	P	420	0.006	0.009	0.012	0.014	0.017
		175 - 225	P	390	0.005	0.008	0.011	0.014	0.017
		225 - 275	P	360	0.005	0.008	0.011	0.014	0.017
		275 - 325	P	340	0.004	0.007	0.010	0.012	0.015
		325 - 375	P	310	0.003	0.007	0.010	0.012	0.015
	High-Strength Alloy 4340, 4330V, 300M, etc.	225 - 300	P	350	0.004	0.007	0.010	0.013	0.015
		300 - 350	P	325	0.003	0.006	0.009	0.012	0.014
		350 - 400	P	300	0.003	0.006	0.008	0.011	0.013
	Structural Steel A36, A285, A516, etc.	100 - 150	P	400	0.006❖	0.010	0.012	0.014	0.018
150 - 250		P	340	0.005❖	0.009	0.010	0.012	0.016	
250 - 350		P	280	0.004❖	0.008	0.009	0.010	0.014	
Tool Steel H-13, H-21, A-4, S-3, etc.	150 - 200	P	220	0.004	0.006	0.008	0.010	0.012	
	200 - 250	P	180	0.004	0.006	0.008	0.010	0.012	
S	High-Temp Alloy Hastelloy B, Inconel 600, etc.	140 - 220	M	110	0.002❖	0.005	0.007	0.008	0.009
		220 - 310	M	85	0.002❖	0.003	0.005	0.006	0.007
	Titanium Alloy	140 - 220	M	150	0.003❖	0.004	0.007	0.008	0.009
		220 - 310	M	120	0.003❖	0.003	0.005	0.006	0.007
	Aerospace Alloy S82	185 - 275	M	150	0.003❖	0.004	0.007	0.008	0.009
275 - 350		M	120	0.003❖	0.003	0.005	0.006	0.007	

❖ Contact our Application Engineering department for assistance when machining these materials.

7xD and 10xD Adjustment Example (0.80 Adjustment)

Data • Adjustment Value	Speed/Feed (7xD)
200 SFM • 0.80	= 160 SFM
0.008 IPR • 0.80	= 0.0064 IPR

12xD and 15xD Adjustment Example (0.70 Adjustment)

Speed • Adjustment Value	Speed/Feed (12xD)
200 SFM • 0.70	= 140 SFM
0.008 IPR • 0.70	= 0.0056 IPR

Coolant Recommendations

Series	Stub, 3xD, 5xD		7xD, 10xD		12xD, 15xD	
	Pressure PSI	Flow Rate GPM	Pressure PSI	Flow Rate GPM	Pressure PSI	Flow Rate GPM
Y	450	4	550	6	650	8
Z	450	4	550	6	650	8
0	350	6	450	9	550	12
1	300	8	400	10	500	12
2	250	10	350	13	450	16
3	200	12	300	14	400	18

**⚠ WARNING** Tool failure can cause serious injury. To prevent:  
 - When using holders without support bushing, use a short T-A Pro holder to establish an initial hole that is a minimum of 2 diameters deep.  
 - Do not rotate tool holders more than 50 RPM unless it is engaged with the workpiece or fixture.  
 Visit [www.alliedmachine.com/DeepHoleGuidelines](http://www.alliedmachine.com/DeepHoleGuidelines) for the most up-to-date information and procedures.  
 Factory technical assistance is available for your specific applications through our Application Engineering department. *email: [engineering.eu@alliedmachine.com](mailto:engineering.eu@alliedmachine.com)*

**IMPORTANT:** The speeds and feeds listed above are a general starting point for all applications. Refer to the coolant recommendation chart for coolant requirements to run at the recommended speeds and feeds. Factory technical assistance is available through our Application Engineering department. For 7xD, 10xD, 12xD and 15xD holder lengths, see adjustment example above.

**Carbide Recommended Drilling Data | Imperial (inch)**

ISO	Material	Hardness (BHN)	Insert Grade	Speed (SFM)	Feed Rate (IPR) by Diameter				
					Y / Z Series (0.3739" - 0.4998")	0 Series (0.4999" - 0.6946")	1 Series (0.6947" - 0.9596")	2 Series (0.9597" - 1.3797")	3 Series (1.3798" - 1.8820")
M	Stainless Steel 400 Series 416, 420, etc.	185 - 275	M	280	0.005❖	0.009	0.010	0.012	0.013
		275 - 350	M	230	0.004❖	0.008	0.009	0.011	0.012
	Stainless Steel 300 Series 304, 316, 17-4PH, etc.	135 - 185	M	280	0.003❖	0.004	0.005	0.008	0.011
		185 - 275	M	250	0.002❖	0.003	0.004	0.007	0.009
	Stainless Steel 300L Series 304L, 316L, etc.	135 - 185	M	325	0.003❖	0.004	0.005	0.008	0.011
		185 - 275	M	280	0.002❖	0.003	0.004	0.007	0.009
	PH Stainless 17-4, 13-8, 15-5	275 - 350	M	280	0.003❖	0.004	0.005	0.008	0.011
		350 - 425	M	250	0.002❖	0.003	0.004	0.007	0.009
Super Duplex Stainless Steel	135 - 185	M	250	0.003❖	0.004	0.005	0.008	0.011	
	185 - 275	M	230	0.002❖	0.003	0.004	0.007	0.009	
H	Wear Plate Hardox®, AR400, T-1, etc.	400	P	70	0.003	0.006	0.008	0.009	0.012
		500	P	45	0.002	0.005	0.007	0.008	0.010
		600	-	-	-	-	-	-	-
	Hardened Steel	300 - 400	P	95	0.003	0.006	0.008	0.009	0.012
400 - 500		P	45	0.002	0.005	0.007	0.008	0.010	
K	SG / Nodular Cast Iron	120 - 150	K	600	0.007	0.012	0.016	0.020	0.024
		150 - 200	K	550	0.006	0.011	0.014	0.018	0.022
		200 - 220	K	500	0.006	0.009	0.012	0.016	0.018
		220 - 260	K	450	0.005	0.007	0.009	0.012	0.014
		260 - 320	K	400	0.004	0.006	0.007	0.009	0.012
N	Cast Aluminium	30	N	1100	0.008	0.013	0.016	0.020	0.022
		180	N	600	0.008	0.013	0.016	0.018	0.022
	Wrought Aluminium	30	N	1100	0.009	0.013	0.017	0.020	0.024
		180	N	600	0.005	0.007	0.010	0.013	0.016
	Aluminium Bronze	100 - 200	N	500	0.006	0.011	0.014	0.018	0.022
		200 - 250	N	300	0.005	0.007	0.009	0.012	0.014
	Brass	100	N	650	0.007	0.012	0.016	0.020	0.024
Copper	60	N	430	0.002	0.003	0.006	0.008	0.010	

❖ Contact our Application Engineering department for assistance when machining these materials.

**7xD and 10xD Adjustment Example (0.80 Adjustment)**

Data • Adjustment Value	Speed/Feed (7xD)
200 SFM • 0.80	= 160 SFM
0.008 IPR • 0.80	= 0.0064 IPR

**12xD and 15xD Adjustment Example (0.70 Adjustment)**

Speed • Adjustment Value	Speed/Feed (12xD)
200 SFM • 0.70	= 140 SFM
0.008 IPR • 0.70	= 0.0056 IPR

**Coolant Recommendations**

Series	Stub, 3xD, 5xD		7xD, 10xD		12xD, 15xD	
	Pressure PSI	Flow Rate GPM	Pressure PSI	Flow Rate GPM	Pressure PSI	Flow Rate GPM
Y	450	4	550	6	650	8
Z	450	4	550	6	650	8
0	350	6	450	9	550	12
1	300	8	400	10	500	12
2	250	10	350	13	450	16
3	200	12	300	14	400	18

**⚠ WARNING**

Tool failure can cause serious injury. To prevent:

- When using holders without support bushing, use a short T-A Pro holder to establish an initial hole that is a minimum of 2 diameters deep.
- Do not rotate tool holders more than 50 RPM unless it is engaged with the workpiece or fixture.

Visit [www.alliedmachine.com/DeepHoleGuidelines](http://www.alliedmachine.com/DeepHoleGuidelines) for the most up-to-date information and procedures.

Factory technical assistance is available for your specific applications through our Application Engineering department. *email: [engineering.eu@alliedmachine.com](mailto:engineering.eu@alliedmachine.com)*

**IMPORTANT:** The speeds and feeds listed above are a general starting point for all applications. Refer to the coolant recommendation chart for coolant requirements to run at the recommended speeds and feeds. Factory technical assistance is available through our Application Engineering department. For 7xD, 10xD, 12xD and 15xD holder lengths, see adjustment example above.

A  
DRILLING  
B  
BORING  
C  
REAMING  
D  
BURNISHING  
E  
THREADING  
X  
SPECIALS

## High-Speed Steel Recommended Drilling Data | Imperial (inch)

ISO	Material	Hardness (BHN)	Insert Grade	Speed (SFM)	Feed Rate (IPR) by Diameter				
					Y / Z Series (0.3739" - 0.4998")	0 Series (0.4999" - 0.6946")	1 Series (0.6947" - 0.9596")	2 Series (0.9597" - 1.3797")	3 Series (1.3798" - 1.8820")
P	Free-Machining Steel 1118, 1215, 12L14, etc.	100 - 150	X	350	0.006	0.010	0.013	0.016	0.020
		150 - 200	X	325	0.006	0.010	0.013	0.016	0.020
		200 - 250	X	300	0.005	0.010	0.013	0.016	0.020
	Low-Carbon Steel 1010, 1020, 1025, 1522, 1144, etc.	85 - 125	X	315	0.006❖	0.009	0.012	0.015	0.019
		125 - 175	X	300	0.005❖	0.009	0.012	0.015	0.019
		175 - 225	X	285	0.005❖	0.008	0.010	0.014	0.018
		225 - 275	X	265	0.005❖	0.008	0.010	0.014	0.018
	Medium-Carbon Steel 1030, 1040, 1050, 1527, 1140, 1151, etc.	125 - 175	X	300	0.006	0.009	0.012	0.015	0.019
		175 - 225	X	285	0.005	0.008	0.010	0.014	0.018
		225 - 275	X	265	0.005	0.008	0.010	0.014	0.018
		275 - 325	X	235	0.004	0.007	0.009	0.012	0.016
	Alloy Steel 4140, 5140, 8640, etc.	125 - 175	X	250	0.006	0.009	0.012	0.014	0.017
		175 - 225	X	235	0.005	0.008	0.011	0.014	0.017
		225 - 275	X	220	0.005	0.008	0.011	0.014	0.017
		275 - 325	X	205	0.004	0.007	0.010	0.012	0.015
		325 - 375	X	190	0.003	0.007	0.010	0.012	0.015
	High-Strength Alloy 4340, 4330V, 300M, etc.	225 - 300	X	135	0.004	0.007	0.010	0.013	0.015
		300 - 350	X	110	0.003	0.006	0.009	0.012	0.014
		350 - 400	X	90	0.003	0.006	0.008	0.011	0.013
	Structural Steel A36, A285, A516, etc.	100 - 150	X	250	0.006❖	0.010	0.012	0.014	0.018
150 - 250		X	210	0.005❖	0.009	0.010	0.012	0.016	
250 - 350		X	175	0.004❖	0.008	0.009	0.010	0.014	
Tool Steel H-13, H-21, A-4, S-3, etc.	150 - 200	X	145	0.004	0.006	0.008	0.010	0.012	
	200 - 250	X	120	0.004	0.006	0.008	0.010	0.012	
S	High-Temp Alloy Hastelloy B, Inconel 600, etc.	140 - 220	X	45	0.003❖	0.007	0.008	0.010	0.012
		220 - 310	X	40	0.003❖	0.006	0.007	0.008	0.010
	Titanium Alloy	140 - 220	X	60	0.003	0.007	0.008	0.010	0.012
		220 - 310	X	50	0.003	0.006	0.007	0.008	0.010
	Aerospace Alloy S82	185 - 275	X	125	0.005	0.008	0.009	0.010	0.014
		275 - 350	X	110	0.004	0.007	0.008	0.008	0.012

❖ Contact our Application Engineering department for assistance when machining these materials.

### 7xD and 10xD Adjustment Example (0.80 Adjustment)

Data • Adjustment Value	Speed/Feed (7xD)
200 SFM • 0.80	= 160 SFM
0.008 IPR • 0.80	= 0.0064 IPR

### 12xD and 15xD Adjustment Example (0.70 Adjustment)

Speed • Adjustment Value	Speed/Feed (12xD)
200 SFM • 0.70	= 140 SFM
0.008 IPR • 0.70	= 0.0056 IPR

### Coolant Recommendations

Series	Stub, 3xD, 5xD		7xD, 10xD		12xD, 15xD	
	Pressure PSI	Flow Rate GPM	Pressure PSI	Flow Rate GPM	Pressure PSI	Flow Rate GPM
Y	450	4	550	6	650	8
Z	450	4	550	6	650	8
0	350	6	450	9	550	12
1	300	8	400	10	500	12
2	250	10	350	13	450	16
3	200	12	300	14	400	18

#### ⚠ WARNING

Tool failure can cause serious injury. To prevent:

- When using holders without support bushing, use a short T-A Pro holder to establish an initial hole that is a minimum of 2 diameters deep.
- Do not rotate tool holders more than 50 RPM unless it is engaged with the workpiece or fixture.

Visit [www.alliedmachine.com/DeepHoleGuidelines](http://www.alliedmachine.com/DeepHoleGuidelines) for the most up-to-date information and procedures.

Factory technical assistance is available for your specific applications through our Application Engineering department. *email: [engineering.eu@alliedmachine.com](mailto:engineering.eu@alliedmachine.com)*

**IMPORTANT:** The speeds and feeds listed above are a general starting point for all applications. Refer to the coolant recommendation chart for coolant requirements to run at the recommended speeds and feeds. Factory technical assistance is available through our Application Engineering department. For 7xD, 10xD, 12xD and 15xD holder lengths, see adjustment example above.

## High-Speed Steel Recommended Drilling Data | Imperial (inch)

ISO	Material	Hardness (BHN)	Insert Grade	Speed (SFM)	Feed Rate (IPR) by Diameter				
					Y / Z Series (0.3739" - 0.4998")	0 Series (0.4999" - 0.6946")	1 Series (0.6947" - 0.9596")	2 Series (0.9597" - 1.3797")	3 Series (1.3798" - 1.8820")
M	Stainless Steel 400 Series 416, 420, etc.	185 - 275	X	125	0.005❖	0.010	0.011	0.012	0.013
		275 - 350	X	110	0.004❖	0.009	0.010	0.011	0.012
	Stainless Steel 300 Series 304, 316, 17-4PH, etc.	135 - 185	X	125	0.005❖	0.007	0.008	0.009	0.012
		185 - 275	X	110	0.004❖	0.006	0.007	0.008	0.011
	PH Stainless 17-4, 13-8, 15-5	275 - 350	X	95	0.003❖	0.004	0.006	0.008	0.010
		350 - 425	X	75	0.003❖	0.004	0.006	0.008	0.010
Super Duplex Stainless Steel	135 - 185	X	125	0.005❖	0.005	0.006	0.006	0.007	
	185 - 275	X	110	0.004❖	0.005	0.005	0.006	0.006	
H	Wear Plate Hardox®, AR400, T-1, etc.	400	X	60	0.003	0.006	0.008	0.009	0.012
		500	X	45	0.002	0.005	0.007	0.008	0.010
		600	-	-	-	-	-	-	-
	Hardened Steel	300 - 400	X	75	0.003	0.006	0.008	0.009	0.012
400 - 500		X	45	0.002	0.005	0.007	0.008	0.010	
K	SG / Nodular Cast Iron	120 - 150	X	300	0.007	0.012	0.016	0.020	0.024
		150 - 200	X	275	0.006	0.011	0.014	0.018	0.022
		200 - 220	X	240	0.006	0.009	0.012	0.016	0.018
		220 - 260	X	215	0.005	0.007	0.009	0.012	0.014
		260 - 320	X	175	0.004	0.006	0.007	0.009	0.012
N	Cast Aluminium	30	X	600	0.008	0.013	0.016	0.020	0.022
		180	X	300	0.008	0.013	0.016	0.018	0.022
	Wrought Aluminium	30	X	900	0.009	0.013	0.017	0.020	0.024
		180	X	600	0.005	0.007	0.010	0.013	0.016
	Aluminium Bronze	100 - 200	X	300	0.006	0.011	0.014	0.018	0.022
		200 - 250	X	250	0.005	0.007	0.009	0.012	0.014
	Brass	100	X	485	0.007	0.012	0.016	0.020	0.024
Copper	60	X	320	0.002	0.003	0.006	0.008	0.010	

❖ Contact our Application Engineering department for assistance when machining these materials.

### 7xD and 10xD Adjustment Example (0.80 Adjustment)

Data • Adjustment Value	Speed/Feed (7xD)
200 SFM • 0.80	= 160 SFM
0.008 IPR • 0.80	= 0.0064 IPR

### 12xD and 15xD Adjustment Example (0.70 Adjustment)

Speed • Adjustment Value	Speed/Feed (12xD)
200 SFM • 0.70	= 140 SFM
0.008 IPR • 0.70	= 0.0056 IPR

### Coolant Recommendations

Series	Stub, 3xD, 5xD		7xD, 10xD		12xD, 15xD	
	Pressure PSI	Flow Rate GPM	Pressure PSI	Flow Rate GPM	Pressure PSI	Flow Rate GPM
Y	450	4	550	6	650	8
Z	450	4	550	6	650	8
0	350	6	450	9	550	12
1	300	8	400	10	500	12
2	250	10	350	13	450	16
3	200	12	300	14	400	18

#### ⚠ WARNING

Tool failure can cause serious injury. To prevent:

- When using holders without support bushing, use a short T-A Pro holder to establish an initial hole that is a minimum of 2 diameters deep.
- Do not rotate tool holders more than 50 RPM unless it is engaged with the workpiece or fixture.

Visit [www.alliedmachine.com/DeepHoleGuidelines](http://www.alliedmachine.com/DeepHoleGuidelines) for the most up-to-date information and procedures.

Factory technical assistance is available for your specific applications through our Application Engineering department. *email: [engineering.eu@alliedmachine.com](mailto:engineering.eu@alliedmachine.com)*

**IMPORTANT:** The speeds and feeds listed above are a general starting point for all applications. Refer to the coolant recommendation chart for coolant requirements to run at the recommended speeds and feeds. Factory technical assistance is available through our Application Engineering department. For 7xD, 10xD, 12xD and 15xD holder lengths, see adjustment example above.

## Tap Drill Information and Formulas | Metric (mm)

Tap Size	Tap Drill Size	Decimal Equivalent (inch)	* Theo % Thread	Probable Mean Oversize	Probable Hole Size	** Probable % Thread
12 X 1.25	27/64	0.4219	79%	0.075 mm	10.79 mm	74%
	10.8 mm	0.4252	74%	0.075 mm	10.88 mm	69%
14 X 2.0	15/32	0.4688	81%	0.075 mm	11.98 mm	78%
	12.0 mm	0.4724	77%	0.075 mm	12.08 mm	74%
14 X 1.5	12.5 mm	0.4921	77%	0.075 mm	12.58 mm	73%
16 X 2.0	14.0 mm	0.5512	77%	0.075 mm	14.08 mm	74%
16 X 1.5	14.5 mm	0.5709	77%	0.075 mm	14.58 mm	73%
	37/64	0.5781	68%	0.075 mm	14.76 mm	64%
18 X 2.5	15.5 mm	0.6102	77%	0.075 mm	15.58 mm	75%
18 X 1.5	16.5 mm	0.6496	77%	0.075 mm	16.58 mm	73%
	21/32	0.6563	68%	0.075 mm	16.75 mm	64%
20 X 2.5	11/16	0.6875	78%	0.075 mm	17.54 mm	76%
	17.5 mm	0.6890	77%	0.075 mm	17.58 mm	74%
20 X 1.5	18.5 mm	0.7283	77%	0.075 mm	18.58 mm	73%
	47/64	0.7344	69%	0.075 mm	18.66 mm	65%
22 X 2.5	49/64	0.7656	79%	0.075 mm	19.52 mm	76%
	19.5 mm	0.7677	77%	0.075 mm	19.58 mm	75%
22 X 1.5	20.5 mm	0.8071	77%	0.075 mm	20.58 mm	73%
	13/16	0.8125	70%	0.075 mm	20.71 mm	66%
24 X 3	13/16	0.8125	86%	0.075 mm	20.71 mm	84%
	21.0 mm	0.8268	76%	0.075 mm	21.08 mm	75%
24 X 2	22.0 mm	0.8661	77%	0.075 mm	22.08 mm	74%
	7/8	0.8750	68%	0.075 mm	22.30 mm	65%
27 X 3	24.0 mm	0.9449	77%	0.075 mm	24.08 mm	75%

### Formulas

1.	<b>RPM</b>	= (318.47 • m/min) / DIA
	where:	
	RPM	= revolutions per minute (rev/min)
	m/min	= speed (m/min)
	DIA	= diameter of drill (mm)
2.	<b>mm/min</b>	= RPM • mm/rev
	where:	
	mm/min	= mm per minute (mm/min)
	RPM	= revolutions per minute (rev/min)
	mm/rev	= feed rate (mm/rev)
3.	<b>m/min</b>	= RPM • 0.003 • DIA
	where:	
	m/min	= speed (m/min)
	RPM	= revolutions per minute (rev/min)
	DIA	= diameter of drill (mm)
4.	<b>Thrust</b>	= 154 • (mm/rev) • DIA • K <sub>m</sub>
	where:	
	Thrust	= axial thrust (N)
	mm/rev	= feed rate (mm/rev)
	DIA	= diameter of drill (mm)
	K <sub>m</sub>	= specific cutting energy (kPa)
5.	<b>Tool Power</b>	= ((mm/rev) • RPM • K <sub>m</sub> • DIA <sup>2</sup> ) / 218604.8
	where:	
	Tool Power	= tool power (HP)
	mm/rev	= feed rate (mm/rev)
	RPM	= revolutions per minute (rev/min)
	K <sub>m</sub>	= specific cutting energy (kPa)
	DIA	= diameter of drill (mm)

### BSP and ISO 7-1

Tap Size	Tap Drill Size	Decimal Equivalent	* Theo % Thread	Probable Mean Oversize	Probable Hole Size	** Probable % Thread
1/4-19	7/16	0.4375	-	0.075 mm	11.19 mm	-
3/8-19	37/64	0.5781	-	0.075 mm	14.76 mm	-
1/2-14	23/32	0.7188	-	0.075 mm	18.33 mm	-
3/4-14	15/16	0.9375	-	0.075 mm	23.89 mm	-

\* Based on nominal tap drill diameter

\*\* Based on 0.075 mm probable mean oversize

To calculate the percent of full thread for a given hole diameter:

$$\% \text{ Thread} = \frac{76.93}{\text{Pitch (mm)}} \cdot (\text{Basic major diameter} - \text{Drill hole size})$$

### Notes

- The above tap drill information represents probable thread percentages for the standard tap drills stocked at Allied Machine. Special insert diameters may be required in order to meet a user specific percentage of thread requirement.
- The 0.075 mm probable mean oversize hole condition is based on optimum cutting conditions. Probable percent of full thread may vary based on less ideal cutting conditions.
- The table and equations on this page are found in the *Machinery's Handbook*. Permission to simplify and print the equations is granted by the editor of the *Machinery's Handbook*.

### Material Constants

Type of Material	Hardness	K <sub>m</sub> (kPa)
Plain Carbon and Alloy Steel	85 - 200 BHN	5.45
	200 - 275 BHN	6.48
	275 - 375 BHN	6.89
	375 - 425 BHN	7.93
High-Temperature Alloys	-	9.93
Titanium Alloy	-	4.96
Stainless Steels	135 - 275 BHN	6.48
	30 - 45 RC	7.45
Cast Iron	100 - 200 BHN	3.45
	200 - 300 BHN	7.45
Copper Alloy	20 - 80 RB	2.96
	80 - 100 RB	4.96
Aluminium Alloy	-	1.52
Magnesium Alloy	-	1.10

## Tap Drill Information and Formulas | Imperial (inch)

### American - Unified Inch Screw Thread

Tap Size	Tap Drill Size	Decimal Equivalent	* Theo % Thread	Probable Mean Oversize	Probable Hole Size	** Probable % Thread
1/2 - 20	29/64	0.4531	72%	0.003	0.4561	68%
9/16 - 12	12.0 mm	0.4724	72%	0.003	0.4754	69%
	31/64	0.4844	83%	0.003	0.4874	80%
9/16 - 18	1/2	0.5000	87%	0.003	0.5030	82%
	13.0 mm	0.5118	70%	0.003	0.5148	66%
	31/64	0.5156	65%	0.003	0.5186	61%
5/8 - 11	17/32	0.5313	79%	0.003	0.5343	77%
5/8 - 12	35/64	0.5469	72%	0.003	0.5499	69%
5/8 - 18	9/16	0.5625	87%	0.003	0.5655	82%
	14.5 mm	0.5709	75%	0.003	0.5739	71%
	37/64	0.5781	65%	0.003	0.5811	61%
11/16 - 12	39/64	0.6094	72%	0.003	0.6124	69%
3/4 - 10	41/64	0.6406	84%	0.003	0.6436	82%
	16.5 mm	0.6496	77%	0.003	0.6526	75%
	21/32	0.6563	72%	0.003	0.6593	70%
3/4 - 12	43/64	0.6719	72%	0.003	0.6749	69%
3/4 - 16	11/16	0.6875	77%	0.003	0.6905	73%
	17.5 mm	0.6890	75%	0.003	0.6920	71%
7/8 - 9	49/64	0.7656	76%	0.003	0.7686	74%
	25/32	0.7813	65%	0.003	0.7843	63%
7/8 - 14	51/64	0.7969	84%	0.003	0.7999	81%
	13/16	0.8125	67%	0.003	0.8155	64%
15/16 - 12	55/64	0.8594	72%	0.003	0.8624	69%
15/16 - 20	57/64	0.8906	72%	0.003	0.8936	68%
1 - 8	22.0 mm	0.8661	82%	0.003	0.8691	81%
	7/8	0.8750	77%	0.003	0.8780	75%
	57/64	0.8906	67%	0.003	0.8936	65%
1 - 12	29/32	0.9063	87%	0.003	0.9093	84%
	59/64	0.9219	72%	0.003	0.9249	69%
1 - 14	15/16	0.9375	67%	0.003	0.9405	64%
1-1/8 - 12	1-1/32	1.0313	87%	0.003	1.0343	84%
	1-3/64	1.0469	72%	0.003	1.0499	69%
1-1/4 - 7	1-7/64	1.1094	76%	0.003	1.1124	74%

### Taper Pipe Thread (NPT)

Tap Size	Tap Drill Size	Decimal Equivalent	* Theo % Thread	Probable Mean Oversize	Probable Hole Size	** Probable % Thread
1/4 - 18	7/16	0.4375	-	0.003	0.4405	-
3/8 - 18	9/16	0.5625	-	0.003	0.5655	-
1/2 - 14	45/64	0.7031	-	0.003	0.7061	-
3/4 - 14	29/32	0.9063	-	0.003	0.9093	-

\* Based on nominal tap drill diameter

\*\* Based on 0.003" probable mean oversize

To calculate the percent of full thread for a given hole diameter:

$$\% \text{ Thread} = \# \text{ of threads per inch} \cdot \frac{(\text{Basic major diameter of thread} - \text{Drill hole size})}{.0130}$$

### Notes

- The above tap drill information represents probable thread percentages for the standard tap drills stocked at Allied Machine. Special insert diameters may be required in order to meet a user specific percentage of thread requirement.
- The 0.003" probable mean oversize hole condition is based on optimum cutting conditions. Probable percent of full thread may vary based on less ideal cutting conditions.
- The table and equations on this page are found in the *Machinery's Handbook*. Permission to simplify and print the equations is granted by the editor of the *Machinery's Handbook*.

### Formulas

1.	<b>RPM</b>	<b>= (3.82 • SFM) / DIA</b>
	where:	
	RPM	= revolutions per minute (rev/min)
	SFM	= speed (ft/min)
	DIA	= diameter of drill (inch)
2.	<b>IPM</b>	<b>= RPM • IPR</b>
	where:	
	IPM	= inches per minute (in/min)
	RPM	= revolutions per minute (rev/min)
	IPR	= feed rate (in/rev)
3.	<b>SFM</b>	<b>= RPM • 0.262 • DIA</b>
	where:	
	SFM	= speed (ft/min)
	RPM	= revolutions per minute (rev/min)
	DIA	= diameter of drill (inch)
4.	<b>Thrust</b>	<b>= 153,700 • IPR • DIA • K<sub>m</sub></b>
	where:	
	Thrust	= axial thrust (lbs)
	IPR	= feed rate (in/rev)
	DIA	= diameter of drill (inch)
	K <sub>m</sub>	= specific cutting energy (lbs/in <sup>2</sup> )
5.	<b>Tool Power</b>	<b>= .6991 • IPR • RPM • K<sub>m</sub> • DIA<sup>2</sup></b>
	where:	
	Tool Power	= tool power (HP)
	IPR	= feed rate (in/rev)
	RPM	= revolutions per minute (rev/min)
	K <sub>m</sub>	= specific cutting energy (lbs/in <sup>2</sup> )
	DIA	= diameter of drill (inch)

### Material Constants

Type of Material	Hardness	K <sub>m</sub> (lbs/in <sup>2</sup> )
Plain Carbon and Alloy Steel	85 - 200 BHN	0.79
	200 - 275 BHN	0.94
	275 - 375 BHN	1.00
	375 - 425 BHN	1.15
High-Temperature Alloys	-	1.44
Titanium Alloy	-	0.72
Stainless Steels	135 - 275 BHN	0.94
	30 - 45 RC	1.08
Cast Iron	100 - 200 BHN	0.50
	200 - 300 BHN	1.08
Copper Alloy	20 - 80 RB	0.43
	80 - 100 RB	0.72
Aluminium Alloy	-	0.22
Magnesium Alloy	-	0.16

A  
DRILLING  
B  
BORING  
C  
REAMING  
D  
BURNISHING  
E  
THREADING  
X  
SPECIALS



## Deep Hole Drilling Guidelines

T-A Pro | 10xD, 12xD and 15xD Holders

A  
DRILLING

- 1. Pilot Hole**  
100 % RPM  
100% mm/rev (IPR)

Establish the pilot hole using the same diameter short drill to a depth of 2xD minimum. Utilise a pilot drill with the same or larger included point angle.

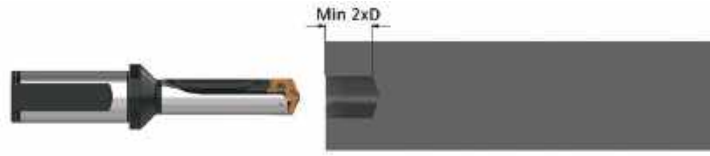

Coolant ON

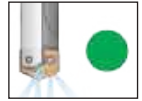

B  
BORING

- 2. Feed-in**  
50 RPM max  
300 mm/min (12 IPM)

Feed the longer drill within 1.5 mm (1/16") short of the established pilot hole bottom at a **maximum of 50 RPM** and 300 mm/min (12 IPM) feed rate.



Coolant OFF



C  
REAMING

- 3. Deep Hole Transition Drilling**  
50 % RPM  
75% mm/rev (IPR)

Drill additional 1xD past the bottom of the pilot hole at 50% reduction of recommended speed and 25% reduction of recommended feed. Minimum of one second dwell is required to meet full speed before feeding.



Coolant ON

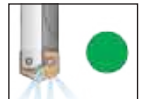

D  
BURNISHING

- 4. Deep Hole Drilling - Blind**  
100% RPM  
100% mm/rev (IPR)

Drill to full depth at recommended speed and feed for longer drill according to Allied speed and feed charts. **No peck cycle recommended.**

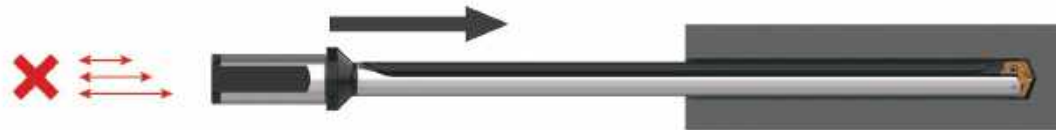

Coolant ON

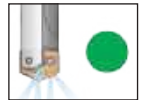

E  
THREADING

- 6. Drill Retract**  
50 RPM max

Reduce speed to a **maximum of 50 RPM** before retracting from the hole.



Coolant OFF



X  
SPECIALS

**1. WARNING** Tool failure can cause serious injury. To prevent:

- When using holders without support bushing, use a short T-A Pro holder to establish an initial hole that is a minimum of 2 diameters deep.
- Do not rotate tool holders more than 50 RPM unless it is engaged with the workpiece or fixture.

Visit [www.alliedmachine.com/DeepHoleGuidelines](http://www.alliedmachine.com/DeepHoleGuidelines) for the most up-to-date information and procedures.

Factory technical assistance is available for your specific applications through our Application Engineering department. email: [engineering.eu@alliedmachine.com](mailto:engineering.eu@alliedmachine.com)



## Troubleshooting Guide

Setup Condition	Potential Problem																			Possible Solutions
	Accelerated corner wear	Barber pole	Bell-mouth hole	Insert chipping	Blue chips	Built-Up Edge (BUE)	Chatter	Chip packing	Chipping of point	Damaged or broken tools	Excessive margin wear	High flank wear	Hole lead off	Hole out of position	Hole out of round	Over-size hole	Poor hole finish	Poor tool life	Power spikes - Load meter	
Worn or misaligned spindle (lathe, screw machine, chucker)	1	2	3				7		9	10	11		13			16	17			<ul style="list-style-type: none"> <li>Align spindle and turret or tailstock.</li> <li>Repair spindle.</li> </ul>
Use of low rigidity machine tools		2	3	4			7		9	10			13	14						<ul style="list-style-type: none"> <li>Reduce penetration rate to fall within the physical limits of the machine or setup (<b>NOTICE:</b> Do not reduce feed below threshold of good chip formation).</li> </ul>
Poor workpiece support		2		4			7			10	11				15		17			<ul style="list-style-type: none"> <li>Provide additional support for the workpiece.</li> <li>Reduce penetration rate to fall within the physical limits of the machine or setup (<b>NOTICE:</b> Do not reduce feed below threshold of good chip formation).</li> </ul>
Flood coolant, low coolant pressure, or low coolant volume	1				5	6		8		10		12				16	17	18	19	<ul style="list-style-type: none"> <li>Run coolant through tool holder when drilling greater than 1xD.</li> <li>Increase coolant pressure and volume through the tool holder.</li> <li>Reduce penetration rate to fall within the coolant limitations (<b>NOTICE:</b> Do not reduce feed below threshold of good chip formation).</li> <li>Add a peck cycle to help clear chips.</li> </ul>
Interrupted cuts. Entry or exit surfaces that are not perpendicular to the spindle (draft angles, parting lines, curved or stepped surfaces, cross holes and cast or forged surfaces)				4			7		9	10	11		13	14	15	16	17	18		<ul style="list-style-type: none"> <li>Pre-mill (spot face) entry or exit surface to remove interruption.</li> <li>Decrease feed as much as 50% through entry or exit interruption.</li> <li>Use short holders in low impact entry cuts.</li> </ul>
Material harder than expected or running tools beyond recommended speed	1				5	6				10		12						18		<ul style="list-style-type: none"> <li>Reduce speed.</li> <li>Increase coolant pressure and volume.</li> <li>Improve coolant condition by use of quality products and regular maintenance.</li> </ul>
Poor material micro-structure or foreign particles (forgings and castings that have not been normalised or annealed, poorly prepared steel, flame cut parts and sand casting)				4		6				10		12	13					18		<ul style="list-style-type: none"> <li>Compare performance of other tools for similar wear problems, which may indicate poor micro-structure. Anneal or normalise parts to improve micro-structure for machining.</li> <li>Reduce feeds (<b>NOTICE:</b> Do not reduce feed below threshold of good chip formation).</li> </ul>
Poor chip control								8		10	11		13			16	17	18	19	<ul style="list-style-type: none"> <li>Increase feed to recommended levels. Contact Allied's Application Engineering group for technical recommendations.</li> <li>Increase coolant pressure and volume.</li> <li>Improve coolant condition by use of quality products and regular maintenance.</li> </ul>
Spot drilled holes with included angle less than that matching T-A Pro or cored holes	1			4			7						13					18		<ul style="list-style-type: none"> <li>Spot hole with short tool of same or greater included angle as T-A Pro drill insert.</li> <li>Reduce feed (<b>NOTICE:</b> Do not reduce feed below threshold of good chip formation). If possible, drill from solid.</li> </ul>

A DRILLING  
B BORING  
C REAMING  
D BURNISHING  
E THREADING  
X SPECIALS

# Drilling Guaranteed Application Form

\*The following must be filled out completely before your test will be considered

## CONTACT DETAILS

Trial P.O. No.\* ..... Date\* ..... Proposed Test Date\* .....  
 Favoured Distributor\* ..... Distributor Contact\* .....  
 Customer Name\* ..... Industry..... Contact Name\* .....

## APPLICATION INFORMATION

ATTENTION: The following Information is required to enable the best combination of tooling to be recommended. Please complete all that apply.  
 Material Type\* ..... Specification\* ..... Material Hardness .....  Kg  BRN  RC  N/mm<sup>2</sup>  
 Material Condition  Flat Stock  Round Stock  Tubular Stock  Plate  
 Stacked Plate  Hot Rolled  Cold Rolled  Casting  Forging  
 Hole Diameter .....  mm  Inch  Hole Depth.....  Through Hole  Blind Hole  
 Drilled Hole Tolerance Req'd ..... Drilled Hole RMS Finished Req'd .....  μInch  μMetre

## MACHINE SETUP

Machine Type  Machining Centre  Lathe  Boring Mill  
 Multi-spindle Auto  Multi-spindle Drill  Transfer Line  
 Gantry Machine  Dial Index Machine  Radial Arm  
 Gun Drilling Machine  Pedestal Drill  Other: .....

Machine Tool Builder\* ..... Model .....

Machine Tool Control\*  CNC  NC  Manual  Other .....

Spindle Orientation\*  Vertical  Horizontal  Other .....

Machine Shank Required  MAS BT  DIN69871  HSK Spindle Taper Size  40  50  63  100  Other .....

Tool\*  Stationary  Revolves

Available Power\*  KW .....  HP ..... Available Feed Trust .....  Newtons  Lbs

Available Speed\*  RPM .....  M/min .....  Variable  Fixed

Preferred Shank Type\*  Flanged  Morse Taper  RCA  Lathe  Diameter .....  mm  Inch

Coolant Type\*  Cutting Oil  Water Soluble Oil  Air Mist  Air  Dry

Coolant Pressure\*  Bar .....  PSI .....

Coolant Flow Rate\*  L/min .....  GPM ..... Coolant Supply  Through Tool  External

## CURRENT DRILL INFORMATION

Drill Manufacturer ..... Part Number .....

Drill Type  Twist  Brazed  Indexable Insert  Gun Drill  
 Removable Tip  Other .....

Tool Grade  HSS  Carbide  Ceramic  Other .....

Tool Coating  Uncoated  TiN  TiCN  TiAlN  Other .....

Current Speed  RPM .....  M/min ..... Current Feed Rate  mm/rev .....  mm/min .....

Average Number of Holes Drilled New ..... After Regrind? .....

Reason(s) for Tool change  Wear  Fracture  Chipping  
 Losing Hole Tolerance  Losing Chip Control  Burr  
 Other .....  Chatter  New Application

What criteria defines a successful test\*  Decreased Cycle Time  Better Chip Control  Safer Process  
 Longer Tool Life  Reduced Cost per Hole  Other .....

Current Annual Usage €/: ..... Current Tools per Annum? .....

\*Required fields where applicable

## FOR OFFICE USE ONLY

Application Engineer:

Number:

Status:

[engineering.eu@alliedmachine.com](mailto:engineering.eu@alliedmachine.com)

Allied Machine & Engineering Co. (Europe) Ltd  
 93 Vantage Point, Pensnett Estate,  
 Kingswinford, DY6 7FR, United Kingdom

+44 (0)1384 400 900  
[www.alliedmachine.com](http://www.alliedmachine.com)



**ALLIED MACHINE  
& ENGINEERING**

**WOHLHAUPTER®**

Holemaking Solutions for Today's Manufacturing

## Warranty Information



Allied Machine & Engineering (“Allied Machine”) warrants to original equipment manufacturers, distributors, industrial and commercial users of its products for one year from the original date of sale that each new product manufactured or supplied by Allied Machine shall be free from defects in material and workmanship.

Allied Machine’s sole and exclusive obligation under this warranty is limited to, at its option, without additional charge, replacing or repairing this product or issuing a credit. For this warranty to be applied, the product must be returned freight prepaid to the plant designated by an Allied Machine representative and which, upon inspection, is determined by Allied Machine to be defective in material and workmanship.

Complete information as to operating conditions, machine, setup, and the application of cutting fluid should accompany any product returned for inspection. This warranty shall not apply to any Allied Machine products which have been subjected to misuse, abuse, improper operating conditions, improper machine setup or improper application of cutting fluid or which have been repaired or altered if such repair or alteration, in the judgement of Allied Machine, would adversely affect the performance of the product.

**THIS WARRANTY IS IN LIEU OF ALL OTHER WARRANTIES, EXPRESS OR IMPLIED, INCLUDING ANY IMPLIED WARRANTY OF MERCHANTABILITY OR FITNESS FOR A PARTICULAR PURPOSE.** Allied Machine shall have no liability or responsibility for any claim, whether in contract, tort or otherwise, for any loss or damage arising out of, connected with, or resulting from the manufacture, sale, delivery or use of any product sold hereunder, in excess of the cost of replacement or repair as provided herein.

Allied Machine shall not be liable in contract or in tort (including, without limitation, negligence, strict liability or otherwise) for economic losses of any kind or for any special, incidental, indirect, consequential, punitive or exemplary damages arising in any way out of the performance of, or failure to perform this agreement.

**ALL PRICES, DELIVERIES, DESIGNS, AND MATERIALS ARE SUBJECT TO CHANGE WITHOUT NOTICE.**



Allied Machine & Engineering Co. Europe Ltd. is registered to ISO 9001:2015 by bsi.



Allied Machine & Engineering is registered to ISO 9001:2015 by DQS.



Wohlhaupter GmbH is registered to ISO 9001:2015 by QUACERT.

## Europe

### Allied Machine & Engineering Co. (Europe) Ltd

93 Vantage Point  
Pensnett Estate  
Kingswinford  
West Midlands  
DY6 7FR England

#### Phone:

+44 (0) 1384 400 900

### Wohlhaupter® GmbH

Maybachstrasse 4  
Postfach 1264  
72636 Frickenhausen  
Germany

#### Phone:

+49 (0) 7022 408-0

## United States

### Allied Machine & Engineering

120 Deeds Drive  
Dover OH 44622  
United States

#### Phone:

+1.330.343.4283

#### Toll Free USA and Canada:

800.321.5537

#### Toll Free USA and Canada:

800.223.5140

### Allied Machine & Engineering

485 W Third Street  
Dover OH 44622  
United States

#### Phone:

+1.330.343.4283

#### Toll Free USA and Canada:

800.321.5537

## Asia

### Wohlhaupter® India Pvt. Ltd.

B-23, 3rd Floor  
B Block Community Centre  
Janakpuri, New Delhi - 110058  
India

#### Phone:

+91 (0) 11.41827044

Your local Allied Machine representative:

[www.alliedmachine.com](http://www.alliedmachine.com)

Allied Machine & Engineering Co. Europe Ltd is registered to **ISO 9001:2015** by bsi.

Allied Machine & Engineering is registered to **ISO 9001:2015** by DQS.

Wohlhaupter GmbH is registered to **ISO 9001:2015** by QUACERT.



Copyright © 2025 Allied Machine and Engineering Corp. – All rights reserved.  
All trademarks designated with the ® symbol are registered in the United States and other countries.

A25-TAP\_EU-EN  
Publish Date: May 2025